



**INFILTRATOR®**  
systems inc.

# Design and Installation Manual for Infiltrator Chambers in Florida



# Florida

| <b>Infiltrator Chambers in Florida</b> |    |
|--|----|
| INTRODUCTION                           | 2  |
| PRODUCTS                               | 4  |
| SYSTEM SIZING                          | 8  |
| CHAMBER CONFIGURATIONS                 | 13 |
| INSTALLATION INSTRUCTIONS              | 20 |
| SPECIAL PROCEDURES                     | 28 |
| WARRANTY                               | 31 |

**Version March 16, 2015 rev**  
**Approved Florida Department of Health, Onsite Sewage Programs**  
**April 6, 2015**

The purpose of this product information sheet is to provide specific design and installation information pertinent for the use of Infiltrator products in Florida.

**For more detailed design information,  
please contact Infiltrator Systems at 1-800-221-4436**



# Florida

## INTRODUCTION

---

### Quick4 Equalizer 36 StraightLock Chamber

The revolutionary patented Quick4 Equalizer 36 StraightLock Chamber is specifically designed for use in bed applications. The StraightLock connection forms a rigid joint that allows chamber rows to remain straight and resistant to movement during backfilling. The MultiPort™ endcap allows multiple piping options and eliminates pipe fittings.

QUICK4 EQ36 STRAIGHTLOCK



### Quick4 Equalizer® 36 Chamber

The patented Quick4 Equalizer 36 Chamber can be installed in a 24-inch wide trench. The chamber offers advanced contouring capability with its Contour Swivel Connection™. The patented MultiPort Endcap, with its six molded-in high and low inlets allows for maximum piping flexibility.

QUICK4 EQUALIZER 36



### Equalizer 36 QuickCut Chamber

The Equalizer 36 QuickCut chamber features a unique premarked cut line, allowing you to create two chambers that are over 4 feet in length. This product innovation offers increased design and installation flexibility, while maintaining structural integrity and long-term performance. The chamber provides greater options for all sites, including tight or sloped lots.

EQUALIZER 36 QUICKCUT



### Quick4 Equalizer 24 HD Chamber

The Equalizer 24 HD chamber was designed to provide exceptional strength when used in trench or bed applications. The chamber's enhanced features, which include an increased wall thickness, structural x-ribs and reinforced connection joints, make it one of the strongest Quick4 chambers available today.

QUICK4 EQUALIZER 24



## INTRODUCTION

---

### Quick4 Equalizer 24 LP Chamber

The Quick4 Equalizer 24 LP chamber was designed for shallow placement applications. The Low Profile Endcap offers a simple overlap design for easy installation.

QUICK4 EQUALIZER 24 LOW PROFILE



### Quick4 Plus Equalizer 36 StraightLock Low Profile (LP) Chamber

The Quick4 Plus Equalizer 36 StraightLock Low Profile (LP) chamber is specifically designed for use in bed applications. The StraightLock connection forms a rigid joint that allows chamber rows to remain straight and resistant to movement during backfilling. This chamber is 4 inches shorter than other Equalizer 36 models allowing for shallower installation. The Quick4 Plus All-in-One 8 and the Quick4 Plus Endcaps are available with this chamber, providing increased flexibility in system configurations.

QUICK4 PLUS EQ36 STRAIGHTLOCK LP CHAMBER



### Quick4 Plus Equalizer 36 Low Profile (LP) Chamber

The Quick4 Plus Equalizer 36 Low Profile (LP) chamber can be installed in a 24-inch-wide trench. This chamber is 4 inches shorter than other Equalizer 36 models allowing for shallower installation where a shallow groundwater table, impervious conditions, or other restrictions limit vertical separation distance. The Quick4 Plus All-in-One 8 and the Quick4 Plus Endcaps are available with this chamber, providing increased flexibility in system configurations.

QUICK4 PLUS EQUALIZER 36 LOW PROFILE



### Quick4 Plus All-in-One 8 Endcap

The Quick4 Plus All-in-One 8 Endcap may be used at the end of a chamber row or in-line with chambers. Pipe connection options include the end, sides or top.

QUICK4 PLUS  
ALL-IN-ONE 8 ENDCAP



### Quick4 Plus Endcap

The Quick4 Plus Endcap is installed at the end of the chamber and allows installation of a pipe from the end only. This endcap does not provide side-inletting capability. Pipe connection options include drill points for gravity or pressure pipe.

QUICK4 PLUS  
ENDCAP



# PRODUCTS

## Quick4 Equalizer 36 StraightLock Chamber

**SIDE AND END VIEWS**  
(not to scale)

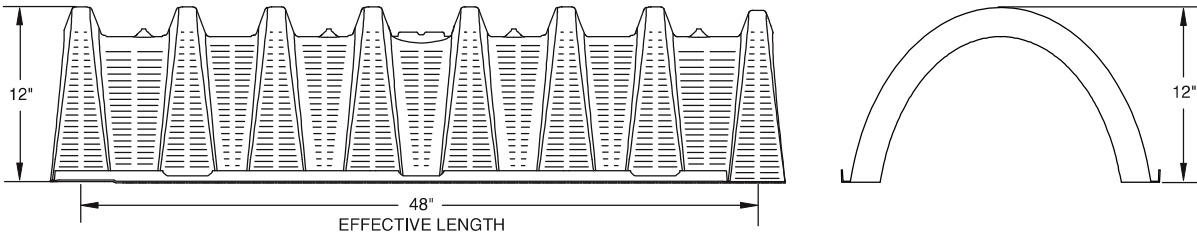

**Quick4 EQ36 StraightLock nominal chamber specifications**

|                  |                    |
|------------------|--------------------|
| Size             | 22"W x 53"L x 12"H |
| Effective Length | 48"                |
| Invert Height    | 6"                 |

**MULTI-PORT ENDCAP**  
(not to scale)

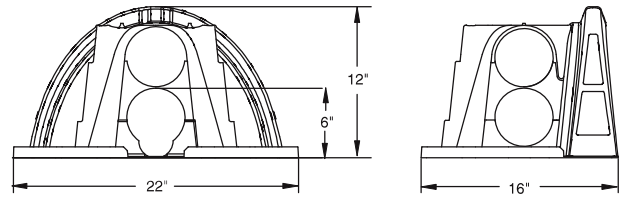

**FRONT VIEW**

**SIDE VIEW**

## Quick4 Equalizer 36 Chamber

**SIDE AND END VIEWS**  
(not to scale)

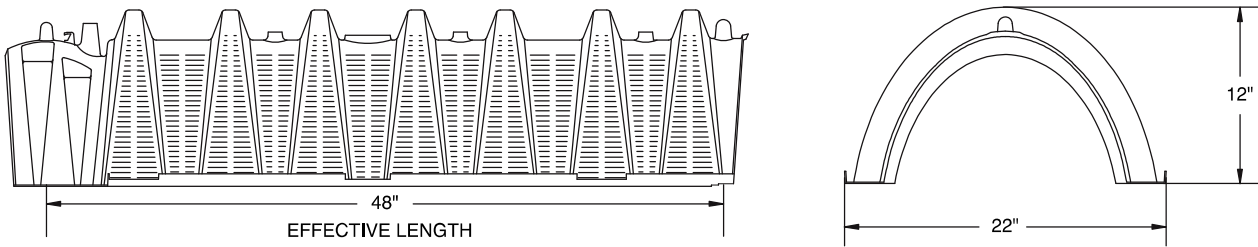

**Quick4 Equalizer 36 nominal chamber specifications**

|                  |                    |
|------------------|--------------------|
| Size (W x L x H) | 22"W x 53"L x 12"H |
| Effective Length | 48"                |
| Invert Height    | 6"                 |

**MULTI-PORT ENDCAP**  
(not to scale)

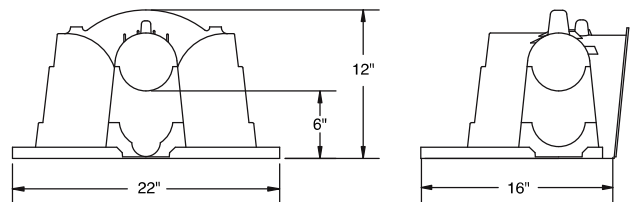

**FRONT VIEW**

**SIDE VIEW**

# PRODUCTS

## Equalizer 36 QuickCut Chamber

**SIDE AND END VIEWS**  
(not to scale)

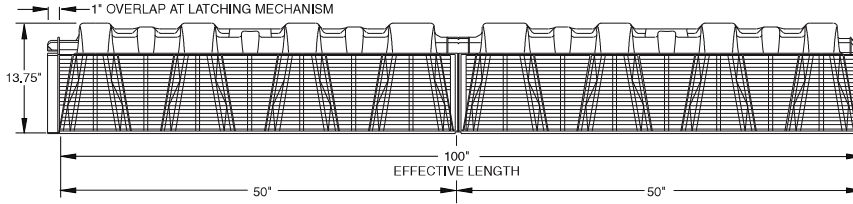

**END PLATES** (not to scale)

**Equalizer 36 QuickCut nominal chamber specifications**

|                  |                       |
|------------------|-----------------------|
| Size (W x L x H) | 22"W x 100"L x 13.5"H |
| Effective Length | 100"                  |
| Invert Height    | 6"                    |

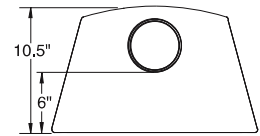
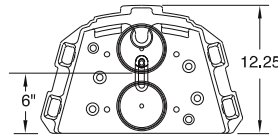

**PART # EQ36-EN**

## Quick4 Equalizer 24 HD Chambers

**SIDE AND END VIEWS**  
(not to scale)

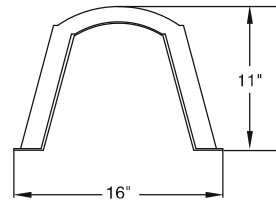
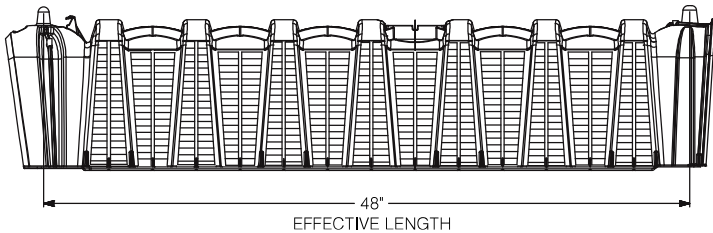

**Quick4 Equalizer 24 HD nominal chamber specifications**

|                  |                    |
|------------------|--------------------|
| Size (W x L x H) | 16"W x 53"L x 11"H |
| Effective Length | 48"                |
| Invert Height    | 6"                 |

**MULTI-PORT ENDCAP**  
(not to scale)

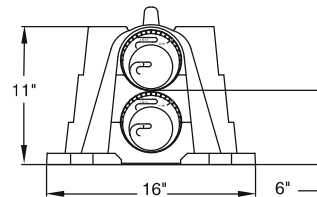

**FRONT VIEW**

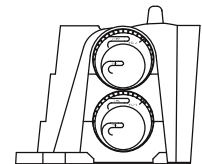

**SIDE VIEW**

# PRODUCTS

## Quick4 Equalizer 24 Low Profile (LP) Chamber

**SIDE AND END VIEWS**  
(not to scale)

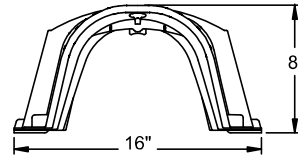
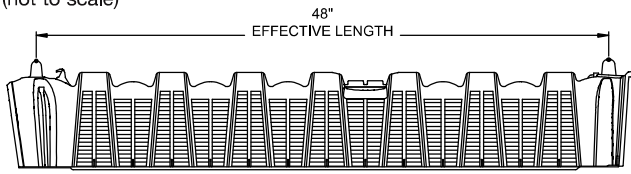

(not to scale)

### Quick4 Equalizer 24 Low Profile (LP) nominal chamber specifications

|                  |                   |
|------------------|-------------------|
| Size (W x L x H) | 16"W x 53"L x 8"H |
| Effective Length | 48"               |
| Invert Elevation | 2"                |

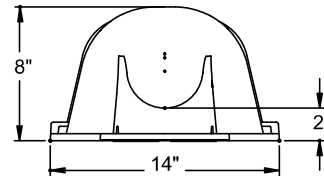

**FRONT VIEW**

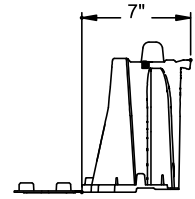

**SIDE VIEW**

## Quick4 Plus Equalizer 36 StraightLock Low Profile (LP) Chambers

**SIDE AND END VIEWS**  
(not to scale)

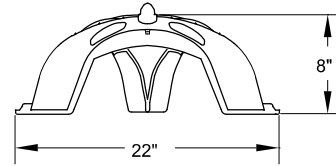
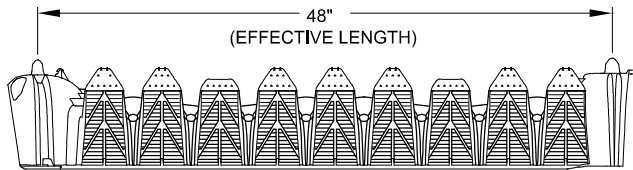

### Quick4 Equalizer 24 Low Profile (LP) nominal chamber specifications

|                  |                   |
|------------------|-------------------|
| Size (W x L x H) | 22"W x 53"L x 8"H |
| Effective Length | 48"               |
| Invert Elevation | 3.3" and 9"       |

**LOW PROFILE ENDCAP**  
(not to scale)

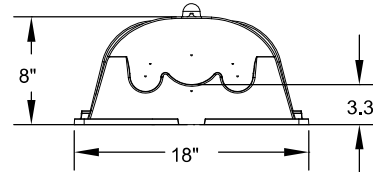

**FRONT VIEW**

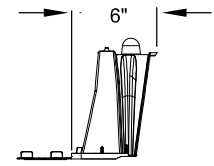

**SIDE VIEW**

## Quick4 Plus Equalizer 36 Low Profile (LP) Chambers

**SIDE AND END VIEWS**  
(not to scale)

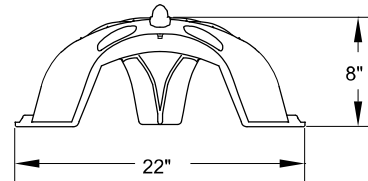
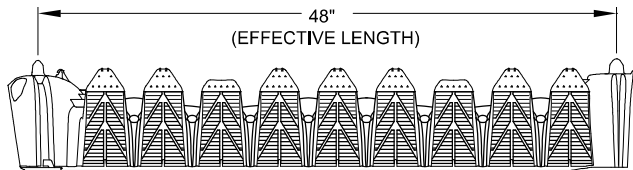

**LOW PROFILE ENDCAP**  
(not to scale)

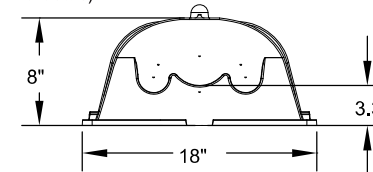

**FRONT VIEW**

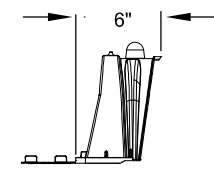

**SIDE VIEW**

### Quick4 Plus Equalizer 36 Low Profile (LP) nominal chamber specifications

|                  |                   |
|------------------|-------------------|
| Size (W x L x H) | 22"W x 53"L x 8"H |
| Effective Length | 48"               |
| Invert Elevation | 3.3" and 9"       |

**PRODUCTS**

---

**Quick4 Plus All-in-One 8 Endcap**

**SIDE AND END VIEWS**  
(not to scale)

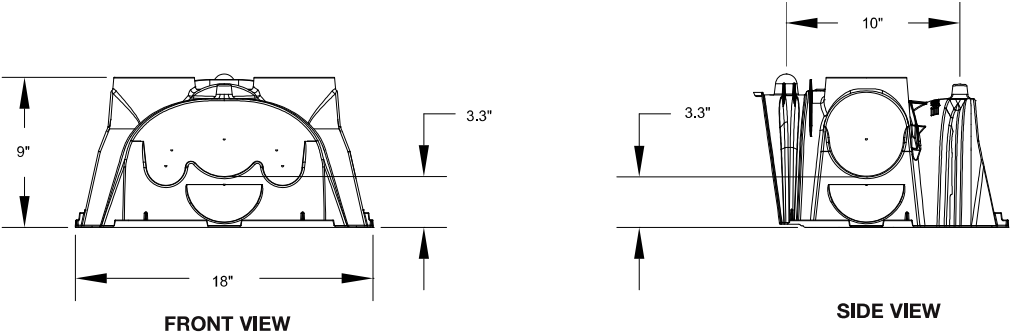

**Quick4 Plus Endcap**

**SIDE AND END VIEWS**  
(not to scale)

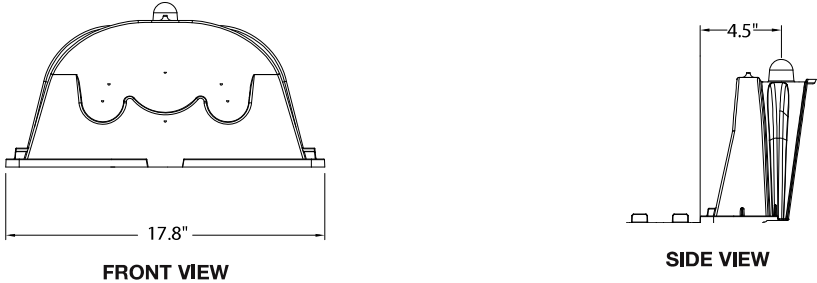

## SYSTEM SIZING

### Chamber System Sizing

TABLE 1: CHAMBER RATINGS

| Chamber   | Rating (sf/chamber) | Trench Width (in) | Min. Bed Spacing (in) |
|---|---------------------|-------------------|-----------------------|
| Quick4 EQ36 Straightlock (22" x 48" x 12")        | 12.00               | 24                | 4                     |
| Quick4 Plus EQ36 Straightlock LP (22" x 48" x 8") | 11.32               | 24                | 0                     |
| Quick4 EQ36 (22" x 48" x 12")                     | 12.00               | 24                | 4                     |
| Quick4 Plus EQ36 LP (22" x 48" x 8")              | 11.32               | 24                | 0                     |
| Equalizer 36 QuickCut (22" x 100" x 13.5")        | 25.00               | 24                | 4                     |
| Quick4 Equalizer 24 HD (16" x 48" x 11")          | 8.00                | 18-24             | 0                     |
| Quick4 Equalizer 24 LP (16" x 48" x 8")           | 7.28                | 18-24             | 0                     |
| Side-by-Side Quick4 Equalizer 24 HD               | 8.57                | 36                | Trench Only           |
| Side-by-Side Quick4 Equalizer 24 LP               | 7.80                | 36                | Trench Only           |

TABLE 2: BED SYSTEMS WIDTH USING MINIMUM SEPARATION

| No. of Rows | Quick4 Plus EQ36 LP <sup>1</sup> | Quick4 EQ24,<br>Quick4 EQ24 LP <sup>1</sup> | Equalizer 36 QuickCut,<br>Quick4 EQ 36 <sup>2</sup> |
|-------------|----------------------------------|---|---|
| 2           | 3' 8"                            | 2' 8"                                       | 4' 0"   |
| 3           | 5' 6"                            | 4' 0"                                       | 6' 2"   |
| 4           | 7' 4"                            | 5' 4"                                       | 8' 4"   |
| 5           | 9' 2"                            | 6' 8"                                       | 10' 6"  |
| 6           | 11' 0"                           | 8' 0"                                       | 12' 8"  |
| 7           | 12' 10"                          | 9' 4"                                       | 14' 10"   |
| 8           | 14' 8"                           | 10' 8"                                      | 17' 0"  |
| 9           | 16' 6"                           | 12' 0"                                      | 19' 2"  |
| 10          | 18' 4"                           | 13' 4"                                      | 21' 4"  |

NOTES:

1. Minimum spacing between chambers is 0". Chambers may be placed edge-to-edge.
2. Minimum space between chambers is 4".
3. Measurements are to the outside edge of chamber.
4. On replaced fill, the one foot perimeter area required for dig-out around the system should be measured from end of chambers and not the endcaps. Endcaps are not given any credit for drainfield area and can be placed within soil replacement perimeter.

TABLE 3: TRENCH SYSTEM WIDTH USING 2-FOOT SEPARATION\*

| No. of Trenches | 22" Chamber System Width | 16" Chamber System Width | Q4 EQ24 and Q4 EQ24 LP<br>Side-by-Side System Width |
|-----------------|--------------------------|--------------------------|---|
| 2               | 5' 8"                    | 4' 8"                    | 8'  |
| 3               | 9' 6"                    | 8' 0"                    | 13'   |
| 4               | 13' 4"                   | 11' 4"                   | 18'   |
| 5               | 17' 2"                   | 14' 8"                   | 23'   |
| 6               | 21' 0"                   | 18' 0"                   | 28'   |
| 7               | 24' 10"                  | 21' 4"                   | 33'   |
| 8               | 28' 8"                   | 24' 8"                   | 38'   |
| 9               | 32' 6"                   | 28' 0"                   | 43'   |
| 10              | 36' 4"                   | 31' 4"                   | 48'   |

NOTES:

1. For 22-inch-wide products, add 3'-10" for each additional trench in excess of 10.
2. For 16-inch-wide products, add 3'-4" for each additional trench in excess of 10.
3. For side-by-side products, add 5' for each additional trench in excess of 10.
4. Measurements are to outside edge of chamber.



# SYSTEM SIZING

## Chamber System Sizing

**TABLE 4: QUICK4 EQ36 STRAIGHTLOCK AND QUICK4 EQ36 CHAMBER LENGTHS AND RATING (TRENCH OR BED SYSTEM CONFIGURATION)**

| No. of Chambers | Length (ft) | Rating (ft <sup>2</sup> ) |
|-----------------|-------------|---------------------------|
| 1               | 4.0         | 12.0                      |
| 2               | 8.0         | 24.0                      |
| 3               | 12.0        | 36.0                      |
| 4               | 16.0        | 48.0                      |
| 5               | 20.0        | 60.0                      |
| 6               | 24.0        | 72.0                      |
| 7               | 28.0        | 84.0                      |
| 8               | 32.0        | 96.0                      |
| 9               | 36.0        | 108.0                     |
| 10              | 40.0        | 120.0                     |
| 11              | 44.0        | 132.0                     |
| 12              | 48.0        | 144.0                     |
| 13              | 52.0        | 156.0                     |
| 14              | 56.0        | 168.0                     |
| 15              | 60.0        | 180.0                     |
| 16              | 64.0        | 192.0                     |
| 17              | 68.0        | 204.0                     |
| 18              | 72.0        | 216.0                     |
| 19              | 76.0        | 228.0                     |
| 20              | 80.0        | 240.0                     |
| 21              | 84.0        | 252.0                     |
| 22              | 88.0        | 264.0                     |
| 23              | 92.0        | 276.0                     |
| 24              | 96.0        | 288.0                     |
| 25              | 100.0       | 300.0                     |
| 26              | 104         | 312.0                     |
| 27              | 108         | 324.0                     |
| 28              | 112         | 336.0                     |
| 29              | 116         | 348.0                     |
| 30              | 120         | 360.0                     |
| 31              | 124         | 372.0                     |
| 32              | 128         | 384.0                     |
| 33              | 132         | 396.0                     |
| 34              | 136         | 408.0                     |
| 35              | 140         | 420.0                     |
| 36              | 144         | 432.0                     |
| 37              | 148         | 444.0                     |
| 38              | 152         | 456.0                     |
| 39              | 156         | 468.0                     |

Note: For minimum sizing on standard and split systems (grey water) refer to Chapter 64E-6 Florida Administrative Code.

Note: Line lengths can not exceed 100 ft except in low-pressure dosing system installations.

**TABLE 5: QUICK4 PLUS EQ36 LP AND QUICK4 PLUS EQ36 LP SL CHAMBER LENGTHS AND RATING (TRENCH OR BED SYSTEM CONFIGURATION)**

| No. of Chambers | Length (ft) | Rating (ft <sup>2</sup> ) |
|-----------------|-------------|---------------------------|
| 1               | 4.0         | 11.3                      |
| 2               | 8.0         | 22.6                      |
| 3               | 12.0        | 33.9                      |
| 4               | 16.0        | 45.2                      |
| 5               | 20.0        | 56.5                      |
| 6               | 24.0        | 67.8                      |
| 7               | 28.0        | 79.1                      |
| 8               | 32.0        | 90.4                      |
| 9               | 36.0        | 101.7                     |
| 10              | 40.0        | 113.0                     |
| 11              | 44.0        | 124.3                     |
| 12              | 48.0        | 135.6                     |
| 13              | 52.0        | 146.9                     |
| 14              | 56.0        | 158.2                     |
| 15              | 60.0        | 169.5                     |
| 16              | 64.0        | 180.8                     |
| 17              | 68.0        | 192.1                     |
| 18              | 72.0        | 203.4                     |
| 19              | 76.0        | 214.7                     |
| 20              | 80.0        | 226.0                     |
| 21              | 84.0        | 237.3                     |
| 22              | 88.0        | 248.6                     |
| 23              | 92.0        | 259.9                     |
| 24              | 96.0        | 271.2                     |
| 25              | 100.0       | 282.5                     |
| 26              | 104         | 293.8                     |
| 27              | 108         | 305.1                     |
| 28              | 112         | 316.4                     |
| 29              | 116         | 327.7                     |
| 30              | 120         | 339.0                     |
| 31              | 124         | 350.3                     |
| 32              | 128         | 361.6                     |
| 33              | 132         | 372.9                     |
| 34              | 136         | 384.2                     |
| 35              | 140         | 395.5                     |
| 36              | 144         | 406.8                     |
| 37              | 148         | 418.1                     |
| 38              | 152         | 429.4                     |
| 39              | 156         | 440.7                     |

Note: For minimum sizing on standard and split systems (grey water) refer to Chapter 64E-6 Florida Administrative Code.

Note: Line lengths can not exceed 100 ft except in low-pressure dosing system installations.

# SYSTEM SIZING

## Chamber System Sizing

**TABLE 6: EQ36 QUICKCUT CHAMBER LENGTHS AND RATING (TRENCH OR BED SYSTEM CONFIGURATION)**

| No. of Chambers | Length (ft) | Rating (ft <sup>2</sup> ) |
|-----------------|-------------|---------------------------|
| 1               | 8' 4"       | 25.0                      |
| 1½              | 12' 6"      | 37.5                      |
| 2               | 16' 8"      | 50.0                      |
| 2½              | 21' 1"      | 62.5                      |
| 3               | 25' 0"      | 75.0                      |
| 3½              | 29' 5"      | 87.5                      |
| 4               | 33' 7"      | 100.0                     |
| 4½              | 37' 9"      | 112.5                     |
| 5               | 42' 1"      | 125.0                     |
| 5½              | 46' 3"      | 137.5                     |
| 6               | 50' 0"      | 150.0                     |
| 6½              | 54' 7"      | 162.5                     |
| 7               | 58' 9"      | 175.0                     |
| 7½              | 63' 2"      | 187.5                     |
| 8               | 67' 4"      | 200.0                     |
| 8½              | 71' 6"      | 212.5                     |
| 9               | 75' 0"      | 225.0                     |
| 9½              | 80' 0"      | 237.5                     |
| 10              | 84' 2"      | 250.0                     |
| 10½             | 88' 4"      | 262.5                     |
| 11              | 92' 6"      | 275.0                     |
| 11½             | 96' 8"      | 287.5                     |
| 12              | 100' 0"     | 300.0                     |
| 12½             | 105' 3"     | 312.5                     |
| 13              | 109' 5"     | 325.0                     |
| 13½             | 113' 7"     | 337.5                     |
| 14              | 117' 9"     | 350.0                     |
| 14½             | 122' 1"     | 362.5                     |
| 15              | 126' 3"     | 375.0                     |
| 15½             | 130' 5"     | 387.5                     |
| 16              | 134' 7"     | 400.0                     |
| 16½             | 138' 9"     | 412.5                     |
| 17              | 143' 1"     | 425.0                     |
| 17½             | 147' 4"     | 437.5                     |
| 18              | 151' 6"     | 450.0                     |
| 18½             | 155' 8"     | 462.5                     |
| 19              | 160' 0"     | 475.0                     |
| 19½             | 164' 2"     | 487.5                     |
| 20              | 168' 4"     | 500.0                     |

Note: Full EQ36 QuickCut Chambers have a rating of 25 ft<sup>2</sup>, half chambers have a rating of 12.5 ft<sup>2</sup>.

Note: Line lengths can not exceed 100 ft except in low-pressure dosing system installations.

**TABLE 7: QUICK4 EQ24 HD CHAMBER LENGTHS AND RATING (SIDE-BY-SIDE TRENCH CONFIGURATION)**

| No. of Chambers | Length (ft) | Rating (ft <sup>2</sup> ) |
|-----------------|-------------|---------------------------|
| 2               | 4.0         | 17.1                      |
| 4               | 8.0         | 34.3                      |
| 6               | 12.0        | 51.4                      |
| 8               | 16.0        | 68.6                      |
| 10              | 20.0        | 85.7                      |
| 12              | 24.0        | 102.8                     |
| 14              | 28.0        | 120.0                     |
| 16              | 32.0        | 137.1                     |
| 18              | 36.0        | 154.3                     |
| 20              | 40.0        | 171.4                     |
| 22              | 44.0        | 188.5                     |
| 24              | 48.0        | 205.7                     |
| 26              | 52.0        | 222.8                     |
| 28              | 56.0        | 240.0                     |
| 30              | 60.0        | 257.1                     |
| 32              | 64.0        | 274.2                     |
| 34              | 68.0        | 291.4                     |
| 36              | 72.0        | 308.5                     |
| 38              | 76.0        | 325.7                     |
| 40              | 80.0        | 342.8                     |
| 42              | 84.0        | 359.9                     |
| 44              | 88.0        | 377.1                     |
| 46              | 92.0        | 394.2                     |
| 48              | 96.0        | 411.4                     |
| 50              | 100.0       | 428.5                     |
| 52              | 104         | 445.6                     |
| 54              | 108         | 462.8                     |
| 56              | 112         | 479.9                     |
| 58              | 116         | 497.1                     |
| 60              | 120         | 514.2                     |
| 62              | 124         | 531.3                     |
| 64              | 128         | 548.5                     |
| 66              | 132         | 565.6                     |
| 68              | 136         | 582.8                     |
| 70              | 140         | 599.9                     |
| 72              | 144         | 617.0                     |
| 74              | 148         | 634.2                     |
| 76              | 152         | 651.3                     |
| 78              | 156         | 668.5                     |

Note: For minimum sizing on standard and split systems (grey water) refer to Chapter 64E-6 Florida Administrative Code.

Note: Line lengths can not exceed 100 ft except in low-pressure dosing system installations.

## SYSTEM SIZING

**TABLE 8: QUICK4 EQ24 HD CHAMBER LENGTHS AND RATING (TRENCH OR BED CONFIGURATION)**

| No. of Chambers | Length (ft) | Rating (ft <sup>2</sup> ) |
|-----------------|-------------|---------------------------|
| 1               | 4.0         | 8.0                       |
| 2               | 8.0         | 16.0                      |
| 3               | 12.0        | 24.0                      |
| 4               | 16.0        | 32.0                      |
| 5               | 20.0        | 40.0                      |
| 6               | 24.0        | 48.0                      |
| 7               | 28.0        | 56.0                      |
| 8               | 32.0        | 64.0                      |
| 9               | 36.0        | 72.0                      |
| 10              | 40.0        | 80.0                      |
| 11              | 44.0        | 88.0                      |
| 12              | 48.0        | 96.0                      |
| 13              | 52.0        | 104.0                     |
| 14              | 56.0        | 112.0                     |
| 15              | 60.0        | 120.0                     |
| 16              | 64.0        | 128.0                     |
| 17              | 68.0        | 136.0                     |
| 18              | 72.0        | 144.0                     |
| 19              | 76.0        | 152.0                     |
| 20              | 80.0        | 160.0                     |
| 21              | 84.0        | 168.0                     |
| 22              | 88.0        | 176.0                     |
| 23              | 92.0        | 184.0                     |
| 24              | 96.0        | 192.0                     |
| 25              | 100.0       | 200.0                     |
| 26              | 104         | 208.0                     |
| 27              | 108         | 216.0                     |
| 28              | 112         | 224.0                     |
| 29              | 116         | 232.0                     |
| 30              | 120         | 240.0                     |
| 31              | 124         | 248.0                     |
| 32              | 128         | 256.0                     |
| 33              | 132         | 264.0                     |
| 34              | 136         | 272.0                     |
| 35              | 140         | 280.0                     |
| 36              | 144         | 288.0                     |
| 37              | 148         | 296.0                     |
| 38              | 152         | 304.0                     |
| 39              | 156         | 312.0                     |

Note: For minimum sizing on standard and split systems (grey water) refer to Chapter 64E-6 Florida Administrative Code.

Note: Line lengths can not exceed 100 ft except in low-pressure dosing system installations.

**TABLE 9: QUICK4 EQ24 LP CHAMBER LENGTHS AND RATING (SIDE-BY-SIDE TRENCH CONFIGURATION)**

| No. of Chambers | Length (ft) | Rating (ft <sup>2</sup> ) |
|-----------------|-------------|---------------------------|
| 2               | 4.0         | 15.6                      |
| 4               | 8.0         | 31.2                      |
| 6               | 12.0        | 46.8                      |
| 8               | 16.0        | 62.4                      |
| 10              | 20.0        | 78.0                      |
| 12              | 24.0        | 93.6                      |
| 14              | 28.0        | 109.2                     |
| 16              | 32.0        | 124.8                     |
| 18              | 36.0        | 140.4                     |
| 20              | 40.0        | 156.0                     |
| 22              | 44.0        | 171.6                     |
| 24              | 48.0        | 187.2                     |
| 26              | 52.0        | 202.8                     |
| 28              | 56.0        | 218.4                     |
| 30              | 60.0        | 234.0                     |
| 32              | 64.0        | 249.6                     |
| 34              | 68.0        | 265.2                     |
| 36              | 72.0        | 280.8                     |
| 38              | 76.0        | 296.4                     |
| 40              | 80.0        | 312.0                     |
| 42              | 84.0        | 327.6                     |
| 44              | 88.0        | 343.2                     |
| 46              | 92.0        | 358.8                     |
| 48              | 96.0        | 374.4                     |
| 50              | 100.0       | 390.0                     |
| 52              | 104         | 405.6                     |
| 54              | 108         | 421.2                     |
| 56              | 112         | 436.8                     |
| 58              | 116         | 452.4                     |
| 60              | 120         | 468.0                     |
| 62              | 124         | 483.6                     |
| 64              | 128         | 499.2                     |
| 66              | 132         | 514.8                     |
| 68              | 136         | 530.4                     |
| 70              | 140         | 546.0                     |
| 72              | 144         | 561.6                     |
| 74              | 148         | 577.2                     |
| 76              | 152         | 592.8                     |
| 78              | 156         | 608.4                     |

Note: For minimum sizing on standard and split systems (grey water) refer to Chapter 64E-6 Florida Administrative Code.

Note: Line lengths can not exceed 100 ft except in low-pressure dosing system installations.

# SYSTEM SIZING

---

## Chamber System Sizing

**TABLE 10: QUICK4 EQ24 LP CHAMBER LENGTHS AND RATING (TRENCH OR BED CONFIGURATION)**

| No. of Chambers | Length (ft) | Rating (ft <sup>2</sup> ) |
|-----------------|-------------|---------------------------|
| 1               | 4.0         | 7.3                       |
| 2               | 8.0         | 14.6                      |
| 3               | 12.0        | 21.8                      |
| 4               | 16.0        | 29.1                      |
| 5               | 20.0        | 36.4                      |
| 6               | 24.0        | 43.7                      |
| 7               | 28.0        | 51.0                      |
| 8               | 32.0        | 58.2                      |
| 9               | 36.0        | 65.5                      |
| 10              | 40.0        | 72.8                      |
| 11              | 44.0        | 80.1                      |
| 12              | 48.0        | 87.4                      |
| 13              | 52.0        | 94.6                      |
| 14              | 56.0        | 101.9                     |
| 15              | 60.0        | 109.2                     |
| 16              | 64.0        | 116.5                     |
| 17              | 68.0        | 123.8                     |
| 18              | 72.0        | 131.0                     |
| 19              | 76.0        | 138.3                     |
| 20              | 80.0        | 145.6                     |
| 21              | 84.0        | 152.9                     |
| 22              | 88.0        | 160.2                     |
| 23              | 92.0        | 167.4                     |
| 24              | 96.0        | 174.7                     |
| 25              | 100.0       | 182.0                     |
| 26              | 104         | 189.3                     |
| 27              | 108         | 196.6                     |
| 28              | 112         | 203.8                     |
| 29              | 116         | 211.1                     |
| 30              | 120         | 218.4                     |
| 31              | 124         | 225.7                     |
| 32              | 128         | 233.0                     |
| 33              | 132         | 240.2                     |
| 34              | 136         | 247.5                     |
| 35              | 140         | 254.8                     |
| 36              | 144         | 262.1                     |
| 37              | 148         | 269.4                     |
| 38              | 152         | 276.6                     |
| 39              | 156         | 283.9                     |

Note: For minimum sizing on standard and split systems (grey water) refer to Chapter 64E-6 Florida Administrative Code.

Note: Line lengths can not exceed 100 ft except in low-pressure dosing system installations.

# CHAMBER CONFIGURATIONS

## Quick4 Equalizer 24 LP Mound Configurations

### CROSS SECTION (not to scale)

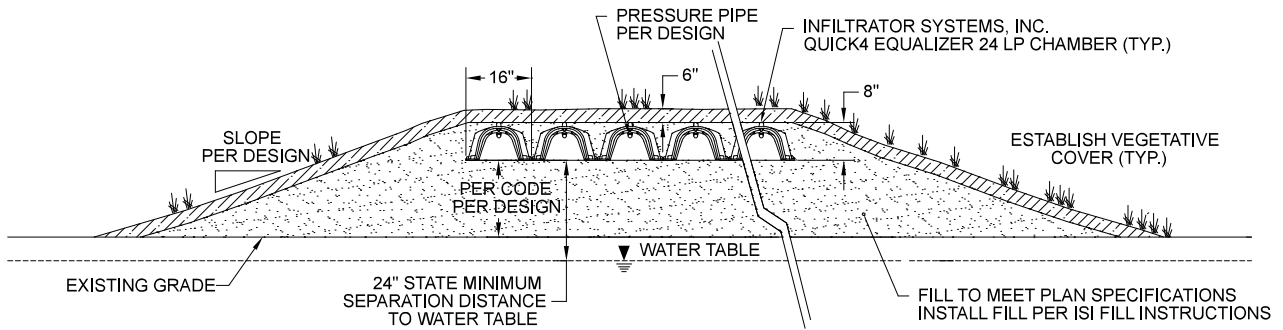

### PLAN VIEW: GRAVITY OR LIFT DOSE (not to scale)

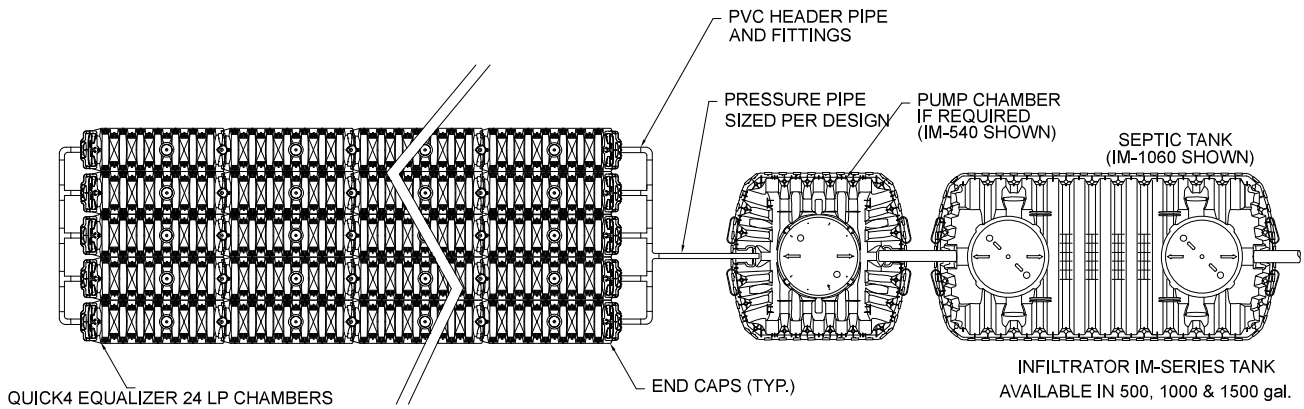

**Notes:**

1. Length and number of chamber rows per design.
2. Design configuration applies to pump, LLP and dosing systems.

# CHAMBER CONFIGURATIONS

## Quick4 Equalizer 24 LP Trench Configurations

CROSS SECTION  
(not to scale)

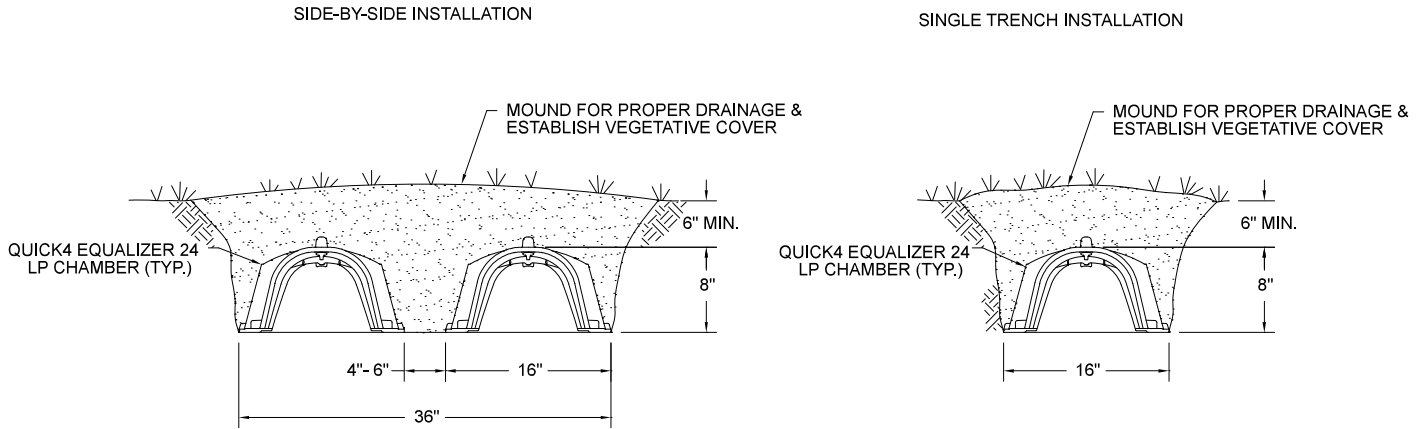

(not to scale)

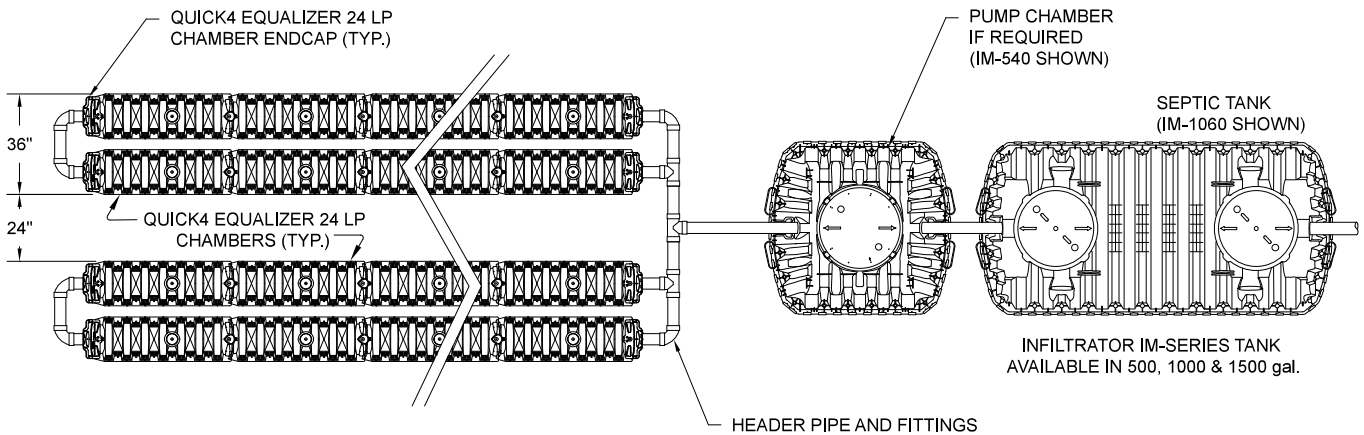

Notes:

1. Length and number of trenches per design.
2. Trench installations require a separation of 2 feet edge to edge.
3. Design configuration applies to pump, LLP and dosing systems.
4. Drill opening at bottom of endcap to connect chambers at endcap.

# CHAMBER CONFIGURATIONS

## Quick4 Equalizer 36 Mound Configurations

### CROSS SECTION (not to scale)

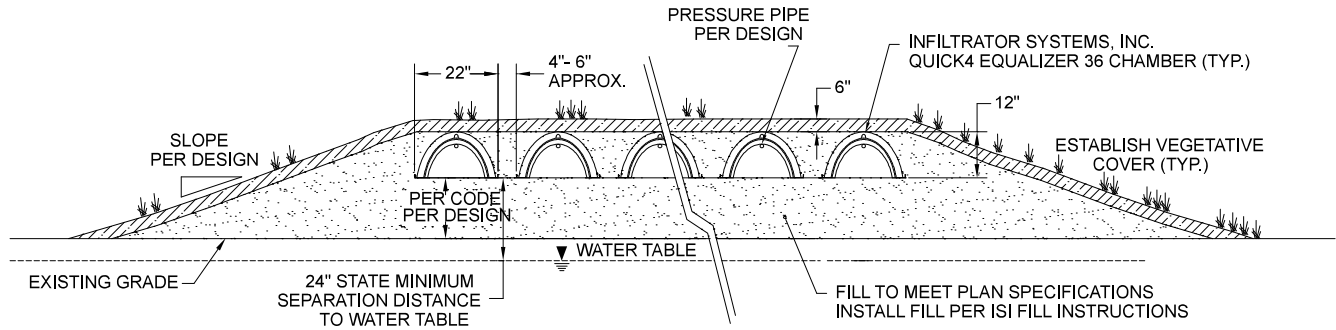

### PLAN VIEW: GRAVITY OR LIFT DOSE (not to scale)

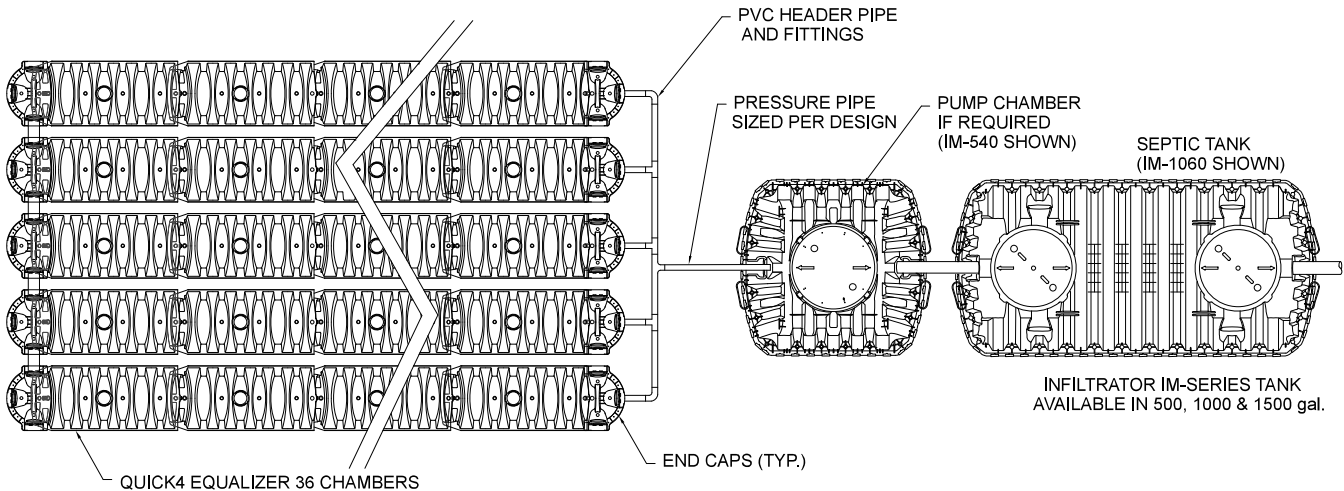

**Notes:**

1. Length and number of chamber rows per design.
2. Design configuration applies to pump, LLP and dosing systems.
3. Looping the distal end is required by 64E-6.014 (5) (i).
4. A 4"-6" space is required between chamber rows.

# CHAMBER CONFIGURATIONS

## Quick4 Equalizer 36 Bed Configurations

### CROSS SECTION (not to scale)

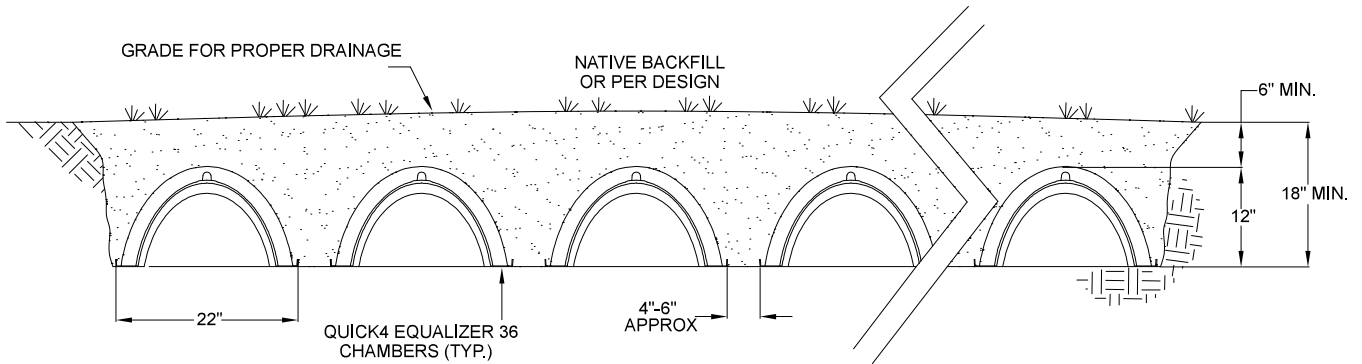

### PLAN VIEW: GRAVITY OR LIFT DOSE (not to scale)

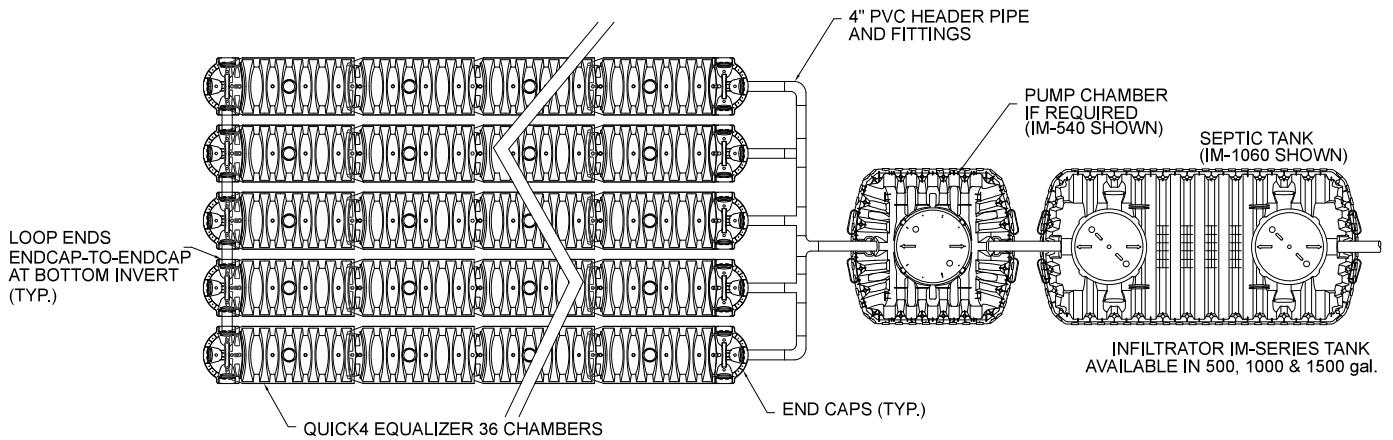

Note: Quick4 Equalizer 36 StraightLock Chambers can also be used in these configurations.

Notes:

1. Length and number of chamber rows per design.
2. Design configuration applies to pump, LLP and dosing systems.
3. Looping the distal end is required by 64E-6.014 (5) (i).
4. A 4"-6" space is required between chamber rows.



# CHAMBER CONFIGURATIONS

## Quick4 Equalizer 36 Trench Configurations

### CROSS SECTION (not to scale)

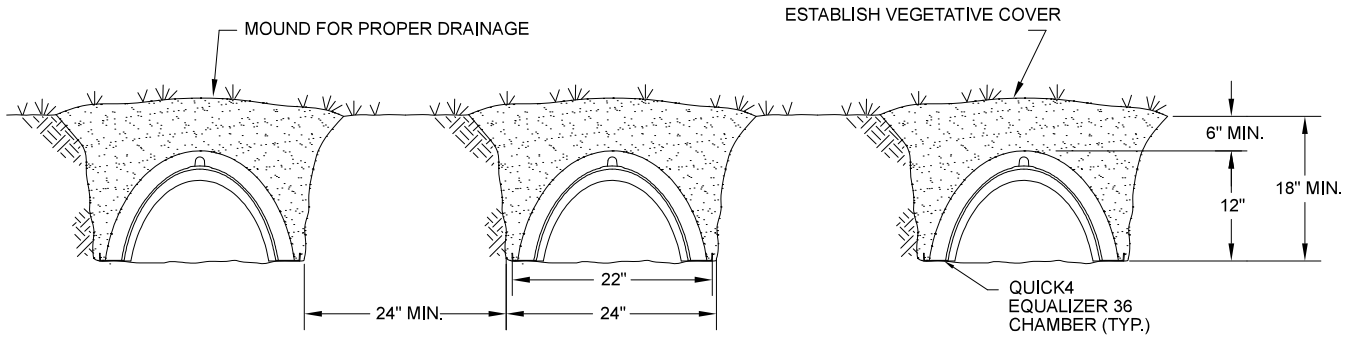

### PLAN VIEW: GRAVITY OR LIFT DOSE (not to scale)

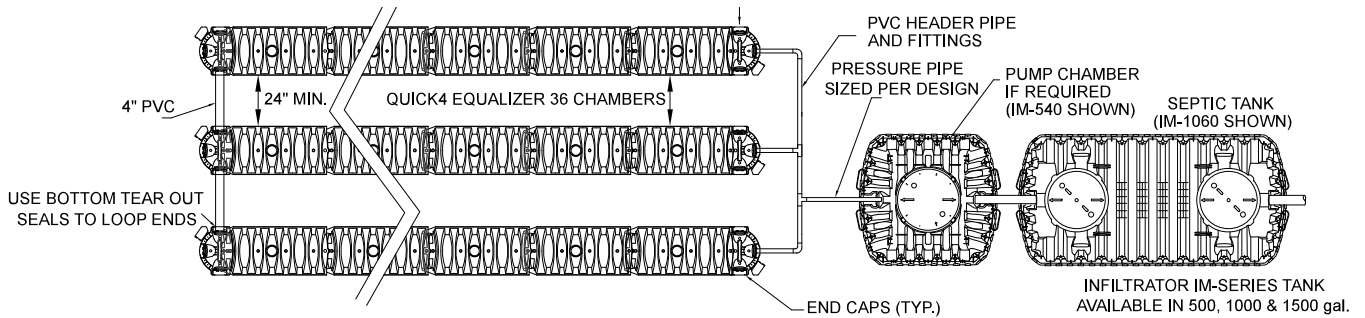

#### Notes:

1. Length and number of trenches per design.
2. Trench installations require a separation of 2 feet edge to edge.
3. Design configuration applies to pump, LLP and dosing systems.
4. Quick4 Equalizer 36 StraightLock Chambers can also be used in all Quick4 Equalizer 36 configurations.
5. Looping the distal end is not required by code, however it will ensure equal distribution to all lines.

# CHAMBER CONFIGURATIONS

## Quick4 Plus Equalizer 36 LP Bed Configurations

**CROSS SECTION**  
(not to scale)

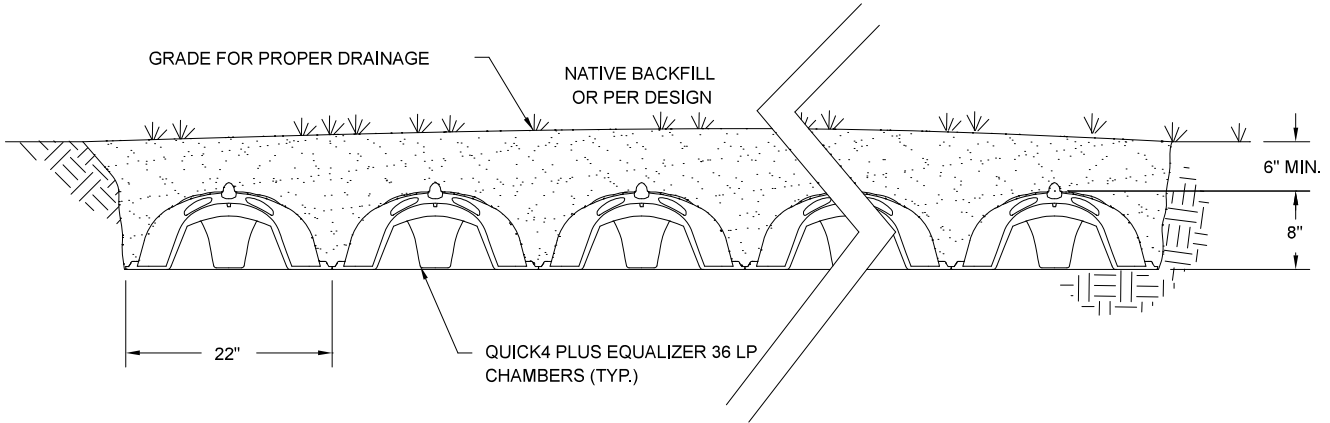

**PLAN VIEW: GRAVITY OR LIFT DOSE**  
(not to scale)

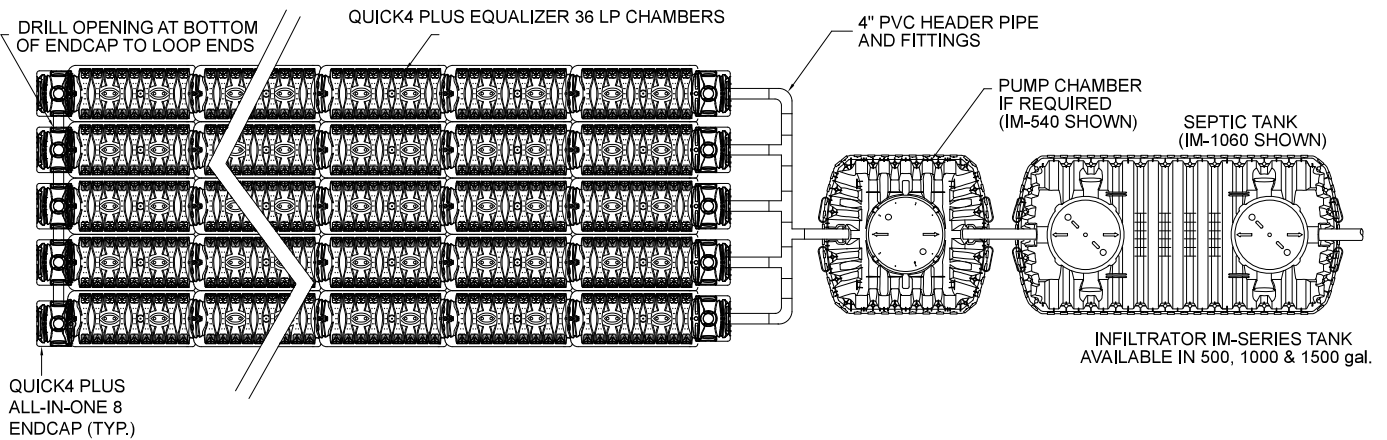

**Notes:**

1. Length and number of chamber rows per design.
2. Design configuration applies to pump, LLP and dosing systems.
3. Looping the distal end is required by 64E-6.014 (5)(i).
4. Quick4 Plus Equalizer 36 StraightLock LP Chambers can also be used in all Quick4 Plus Equalizer 36 LP configurations.
5. Endcaps may be Quick4 Plus Endcap or Quick4 Plus All-in-One 8 Endcap, depending upon piping configurations.

# CHAMBER CONFIGURATIONS

## Quick4 Plus Equalizer 36 LP Trench Configurations

### CROSS SECTION (not to scale)

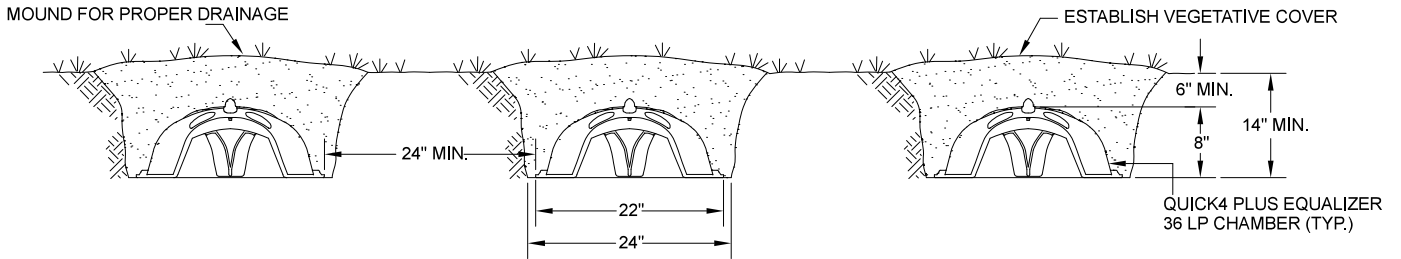

### PLAN VIEW: GRAVITY OR LIFT DOSE (not to scale)

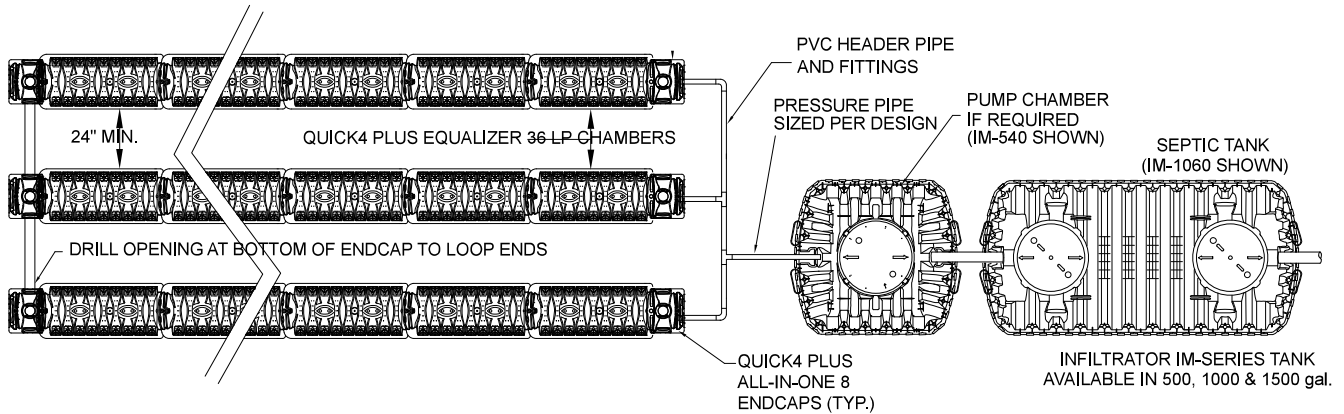

#### Notes:

1. Length and number of trenches per design.
2. Trench installations require a separation of 2 feet edge to edge.
3. Design configuration applies to pump, LLP and dosing systems.
4. Quick4 Plus Equalizer 36 StraightLock LP Chambers can also be used in all Quick4 Plus Equalizer 36 LP configurations.
5. Looping the distal end is not required by code, however it will ensure equal distribution to all lines.
6. Endcaps may be Quick4 Plus Endcap or Quick4 Plus All-in-One 8 Endcap, depending upon piping configurations.

# INSTALLATION INSTRUCTIONS

## Bed Systems

### Before You Begin

**Quick4 EQ36 StraightLock (SL), Quick4 Plus EQ36 StraightLock Low Profile (LP) and Quick4 Equalizer 24 Low Profile (LP) Chambers may only be installed according to state and/or local regulations. If unsure of the installation requirements for a particular site, be sure to contact your local regulator.**

**Like conventional systems, the soil and site conditions must be approved prior to installation. Conduct a thorough site evaluation to determine the proper sizing and siting of the system before installation.**

#### Materials and Equipment Needed

- Quick4 EQ36 StraightLock, Quick4 Plus EQ36 StraightLock LP, or Q4 EQ24 LP chambers
- MultiPort, Quick4 Plus All-in-One 8, Quick4 Plus, or Quick4 Low Profile Endcaps
- 4" Diameter Pipe for Header and Inlet
- Backhoe / Excavator
- Laser, Transit, or Level
- Shovel and Rake
- Tape Measure
- Utility Knife / Screwdriver
- Screw Gun\*
- 2-inch Drywall Screws\*

\*Optional

#### These guidelines for construction machinery must be followed during installation:

- Avoid direct contact with chambers when using construction equipment. Chambers require a 12-inch minimum of compacted cover to support a wheel load rating of 16,000 lbs/axle or equivalent to an H-10 AASHTO load rating.
- Only drive across the system when necessary.
- Never drive down the length of the system.
- To avoid additional soil compaction, never drive heavy vehicles over the completed system.

### Excavating and Preparing the Site

**NOTE:** A State of Florida Department of Health Construction Permit (Form DH 4016) must be obtained before any system is constructed, modified or repaired. Form DH 4016 will specify all necessary information for constructing and repairing an onsite sewage system. Tank/drain field size, elevations, system configurations, and fill/excavation required can all be found on this form.

1. Stake out the location of drainfield area. Set the elevations of the tank, pipe, and drainfield bottom in accordance with specifications on Form DH 4016.

2. Excavate and level drainfield area.

**NOTE:** The bed should be installed level or no more than 1" per 10' of fall per Chapter 64E-6 of the Florida Administrative Code.

### Preparing Q4 EQ36 SL MultiPort Endcaps

1. With a utility knife start the tear-out seal at the appropriate diameter for the inlet pipe. The seal allows for a tight fit for 4-inch SDR35, and 4-inch SCH40 pipe.
2. Pull the tab on the tear-out seal to create an opening on the endcap.
3. Snap off the molded splash plate located on the bottom front of the endcap.
4. Install splash plate into the appropriate slots below the inlet to prevent trench bottom erosion.
5. Insert the inlet pipe into the endcap at the beginning of the trench. The pipe will go in one inch before reaching a stop. (Screws optional.)

### Preparing Q4 Plus EQ36 SL LP Endcap

Note: Quick4 Plus and Quick4 Plus All-in-One 8 Endcaps are available for use with the Quick4 Plus EQ36 StraightLock Low Profile chambers on either end of the trench, depending upon installer's preference and configuration requirements.

1. With a hole saw drill an opening appropriate for pipe diameter being used (normally 3 - 4 inches) on front or side of endcap using center point marking (see illustration below) as a guide.

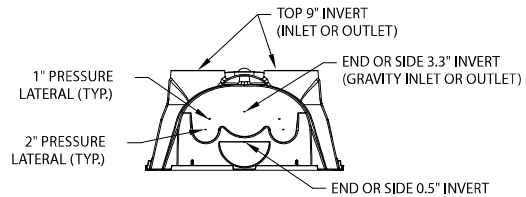

2. Snap off the molded splash plate located on the bottom front of the endcap.
3. Install splash plate into the appropriate slots below the inlet to prevent trench bottom erosion.

# INSTALLATION INSTRUCTIONS

## Bed Systems

### Preparing Q4 EQ24 LP Endcap

1. With a hole saw drill a opening appropriate to the pipe diameter being used (normally 3 to 4 inches) on the front of the endcap.
2. Snap off the molded splash plate located on the bottom front of the endcap.
3. Install splash plate into the appropriate slots below the inlet to prevent trench bottom erosion.

### Installing the System with Q4 EQ36 SL

1. Place the first chamber into the excavated and leveled area with the chamber-end marked "INLET" facing the tank/ header.
2. Place the next chamber (inlet end facing tank/ header) onto the previous one by overlapping the raised corrugation.



2 Connect the chambers.

Note: If installing a bed system, check the spacing between chambers to ensure approx. 4 to 6 inches of separation.

3. To connect chambers and engage Straight-Lock connection, simply push down on the chamber with your hand until it snaps into place. Note locking tab engage through the opening in the chamber corrugation.



3 Engage the connection.

4. Continue installing chambers until the system is completed.

Note: Due to various site locations, if chambers are installed with inlet side toward distal end, this will not affect performance.

### Attaching the Q4 EQ36 SL MultiPort Endcap

1. Lift up the open end of the chamber while sliding the endcap under the chamber.
2. Align the raised corrugation and lower the chamber so that it overlaps the endcap.



1 Slide endcap under chamber.

Note: The endcap should be overlapped by the chamber on both the inlet and outlet ends.

Optional: Secure the endcap in place with a drywall screw.

### Installing the System with Q4 Plus EQ36 SL LP

1. Place the first chamber into the excavated and leveled area.

2. Place the back edge of the endcap over the inlet end of the first chamber. Be sure to line up the locking pins on the top of both the chamber and endcap.



2 Place endcap inlet end.

Optional: Fasten the endcap to the chamber with a screw at the top of endcap.

3. Insert the inlet pipe 2.5 inches into the opening on the front of the endcap.



3 Insert inlet pipe.

4. Lift and place the end of the next chamber onto the previous chamber by holding it at a 45-degree angle.

Line up the chamber end between the connector hook and locking pin at the top of the first chamber. Lower the chamber to the ground to connect the chambers.

Note: When the chamber end is placed between the connector hook and locking pin at a 45-degree angle, the pin will be visible from the back side of the chamber.



4 Connect chambers.

Note: The connector hook serves as a guide to ensure proper connection and does not add structural integrity to the chamber joint. Broken hooks will not affect the structure or void the warranty.

5. Continue connecting chambers until the system is completed.

Note: As chambers are installed, verify they are level or have the prescribed slope.

# INSTALLATION INSTRUCTIONS

## Bed Systems

### Attaching the Q4 Plus EQ36 SL LP Endcap

1. The last chamber in the trench requires an endcap. Lift the endcap at a 45-degree angle and align the connector hook on the top of the chamber with the raised slot on the top of the endcap. Lower the endcap to the ground and into place.



Place endcap outlet end.

**NOTE:** Place a few shovels of soil around the endcap to secure it during backfill.

### Installing the System with Q4 EQ24 LP

1. Place the first chamber in the excavated and leveled area.
2. Place the back edge of the endcap over the inlet end of the first chamber. Be sure to line up the locking pins on the top of both the chamber and endcap.

Optional: Fasten the endcap to the chamber with a screw at the top of the endcap.

3. Insert the header pipe 2.5 inches into the opening on the front of the endcap.

4. Lift and place the end of the next chamber onto the previous chamber by holding it at a 45-degree angle. Line up the chamber end between the connector hook and locking pin at the top of the first chamber.



Connect chambers.

Lower the chamber to the ground to connect the chambers.

**Note:** When the chamber end is placed between the connector hook and locking pin at a 45-degree angle, the pin will be visible from the back side of the chamber.

**Note:** The connector hook serves as a guide to ensure proper connection and does not add structural integrity to the chamber joint. Broken hooks will not affect the structure or void the warranty.

5. Swivel the chamber on the pin to achieve the proper direction for the trench layout.
6. Continue connecting the chambers until the trench is completed.

### Attaching Q4 EQ24 LP Endcaps

1. Lift the endcap at a 45-degree angle and align the connector hook on the top of the chamber with the raised slot on the top of the endcap. Lower the endcap to the ground and into place.

**NOTE:** Place a few shovels of soil around the endcap to secure it during backfill.



### Installing Header and Footer

1. Install the header assembly level with the inlet "T" and as close to the center of the system as possible. The header is installed to the upper opening of the endcap.

2. Pack the soil around the header to secure the assembly and provide support for easier leveling.

**Note:** An optional drywall screw can be used at the 12 o'clock position to secure the pipe to the endcap. If a footer assembly is required (bed/mound) the side ports of the endcap may be connected using 24" sections of pipe.

**Note:** The bottom ports of the endcap shall be used for continuous circuit in a bed.

3. The system is now ready for Department of Health inspection.

### Installing Optional Inspection Ports in Endcaps

1. With a hole saw drill the pre-marked area in the top of the endcap to create a 4-inch opening.

2. Set a cut piece of pipe of the appropriate length into the corresponding chamber's inspection port sleeve.

**Note:** The sleeve will accommodate a 4-inch SCH40 pipe.

3. Use two screws to fasten the pipe to the sleeve around the inspection port.

4. Attach a threaded cap or cleanout assembly onto the protruding pipe at the appropriate height.

5. A small valve cover box may be used if inspection port is below the desired grade.



All-in-One 8 inspection port.

# INSTALLATION INSTRUCTIONS

## Bed Systems

### Installing Optional Inspection Ports in Chambers

1. With a hole saw drill the pre-marked area in the top of the chamber to create a 2.5-inch opening.

2. Set a cut piece of pipe of appropriate length into the corresponding chamber's inspection port sleeve.

Note: The sleeve will accommodate up to a 2.5-inch Schedule 40 pipe.



Chamber inspection port.

3. Use two screws to fasten the pipe to the sleeve around the inspection port.

4. Attach a threaded cap or cleanout assembly onto the protruding pipe at the appropriate height.

5. A small valve cover box may be used if the inspection port is below the desired grade.

### Backfilling and Covering the System

Before backfilling, the system must be inspected by a health officer or other official as required by State and local codes. Create an as-built drawing at this time for future records.

1. Ladle soil with a backhoe bucket or carefully dump soil on the dome of the chambers and spread in between.

2. Pack down fill by walking along the edges of bed and chambers.

**NOTE:** In wet or clay soils, do not walk in the sidewalls.

3. When placing final cover on the system, backfill by building a ramp of compacted soil (2 feet approx.) and broadcast the cover material over the system with a small-tracked dozer, backhoe, or Bobcat. Be sure to cover the system perpendicular to the chambers and do not drive heavy equipment lengthwise on the chambers.

**NOTE:** Chapter 64 E-6 of the Florida Administrative Code requires a minimum of 6 inches of compacted cover after natural settling on standard installation. Mounded and Fill Systems require a soil cap of slightly or moderately limited soil material over the drainfield and shoulder area. The soil cap shall be no less than 6 inches thick at the outer perimeter of the shoulder.

4. Seed or sod the site (per state and local requirements), shortly after final cover and be sure that the area is graded for proper drainage.



1

Ladle soil on chamber domes.



3

Build ramp of soil.

# INSTALLATION INSTRUCTIONS

## Trench Systems

### Before You Begin

**Quick4 Chambers may only be installed according to State and/or local regulations. If unsure of the installation requirements for a particular site, contact the local health department.**

Like conventional systems, the soil and site conditions must be approved prior to installation. Conduct a thorough site evaluation to determine the proper sizing and siting of the system before installation.

### Materials and Equipment Needed

- |   |  |
|---|--|
| <input type="checkbox"/> Quick4 or Quick4 Plus Chambers   | <input type="checkbox"/> Tape Measure                |
| <input type="checkbox"/> MultiPort or Quick4 Plus Endcaps | <input type="checkbox"/> Utility Knife / Screwdriver |
| <input type="checkbox"/> Backhoe / Excavator              | <input type="checkbox"/> Screw Gun*                  |
| <input type="checkbox"/> Laser, Transit, or Level         | <input type="checkbox"/> 2-inch Drywall Screws*      |
| <input type="checkbox"/> Shovel and Rake                  | *Optional  |

### These guidelines for construction machinery must be followed during installation:

- Avoid direct contact with chambers when using construction equipment. Chambers require a 12-inch minimum of compacted\*\* cover to support a wheel load rating of 16,000 lbs/axle or equivalent to an H-10 AASHTO load rating.
- Only drive across the trenches when necessary. Never drive down the length of the trenches.
- To avoid additional soil compaction, never drive heavy vehicles over the completed system.

\*\*Compacted to a comparable level of native soil.

## Excavating and Preparing the Site

**NOTE:** A State of Florida Department of Health Construction Permit (Form DH 4016) must be obtained before any system is constructed, modified or repaired. Form DH 4016 will specify all necessary information for constructing and repairing an onsite sewage system. Tank/drain field size, elevations, system configurations, and fill/excavation required can all be found on this form.

1. Stake out the location of all trenches and lines. Set the elevations of the tank, pipe, and trench bottom in accordance with specifications on Form DH 4016.
2. Install sedimentation and erosion control measures. Temporary drainage swales/berms may be installed to protect the site during rainfall events.
3. Excavate and level 2-foot wide trenches with proper center-to-center separation. Verify that the trenches are approximately level or have the prescribed fall of no more than 1" per 10' of trench length.

**NOTE:** Over excavate the trench width in areas where you are planning to contour.

## Preparing the MultiPort Endcap

1. With a screwdriver or utility knife start the tear-out seal at the appropriate diameter for the inlet pipe. The seal allows for a tight fit for 3-inch, 4-inch SDR35, and 4-inch SCH40 pipe.
2. Pull the tab on the tear-out seal to create an opening on the endcap.
3. Snap off the molded splash plate located on the bottom front of the endcap.
4. Install splash plate into the appropriate slots below the inlet to prevent trench bottom erosion.
5. Insert the inlet pipe or hub of fitting into the endcap at the beginning of the trench.



1 Start tear-out seal.



2 Pull tab on tear-out seal.



4 Install splash plate.



5 Insert inlet pipe.



# INSTALLATION INSTRUCTIONS

## Trench Systems

### Preparing the Q4 Plus EQ36 LP Endcap

Note: Quick4 Plus and Q4 Plus All-in-One 8 Endcaps are available for use with Quick4 Plus chambers on either end of trench, depending upon installer's preference and configuration requirements.

1. With a hole saw drill an opening appropriate for pipe diameter being used (normally 3 - 4 inches) on front or side of endcap using center point marking (see illustration below) as a guide.



1 Drill endcap.

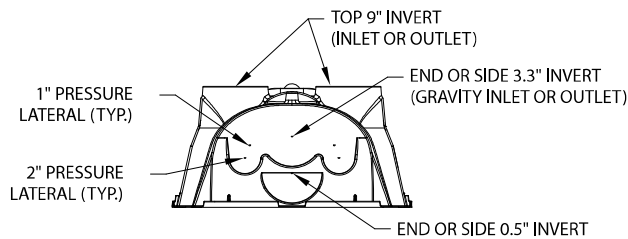

2. Snap off the molded splash plate located on the bottom front of the endcap.
3. Install splash plate into the appropriate slots below the inlet to prevent trench bottom erosion.

### Installing the Quick4 System

1. Check the header pipe to be sure it is level or has the prescribed slope.
2. Place the inlet end of the first chamber over the back edge of the endcap.
3. Lift and place end of next chamber onto previous chamber by holding it at a 45-degree angle. Line up chamber end between the connector hook and locking pin at top of the first chamber. Lower it to the ground to connect the chambers.

Note: When chamber end is placed between connector hook and locking pin at a 45-degree angle, pin will be visible from back side of chamber.



2 Place first chamber onto endcap.



3 Connect the chambers.

Note: Connector hook serves as a guide to ensure proper connection and does not add structural integrity to the chamber joint. Broken hooks will not affect structure or void warranty.

4. Swivel the chamber on the pin to the proper direction for the trench layout.

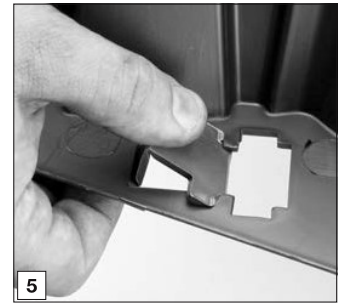

5 Activate StraightLock Tabs.

5. Where the system design requires straight runs, use the StraightLock Tabs to ensure straight connections. To activate the tabs, pop the tabs up with your thumb and lock into place.

6. Continue connecting the chambers until the trench is completed.

7. The last chamber in the trench requires an endcap. Lift the endcap at a 45-degree angle and insert the connector hook through the opening on the top of the endcap. Applying firm pressure, lower the endcap to the ground to snap it into place. Do not remove the tear-out seal.



7 Attach endcap to chamber.

Note: Use straight lengths of pipe with the MultiPort Endcap at the trench ends to create fitting-free looped ends (continuous circuit).

8. With the system ready for inspection, shoot the trench for level grade at the beginning, midpoint and end of trench.
9. To backfill the chambers, fill the sidewall area by pulling soil from the sides of the trench. Continue backfilling the entire sidewall area, making sure the fill covers the louvers.
10. Proceed to the next trench and begin with Step 1.

# INSTALLATION INSTRUCTIONS

## Trench Systems

### Installing the Quick4 Plus EQ36 LP System

1. Check the header pipe to be sure it is level or has the prescribed slope.

2. Set the invert height as specified in the design from the bottom of the inlet.

3. Place the first chamber in the trench.

4. Place the back edge of the endcap over the inlet end of the first chamber. Be sure to line up the locking pins on the top of both the chamber and endcap.

Optional: Fasten the endcap to the chamber with a screw at the top of the endcap.

5. Insert the inlet pipe 2.5 inches into the opening on the front of the endcap.

6. Lift and place the end of the next chamber onto previous chamber by holding it at a 45-degree angle. Line up the chamber end between the connector hook and locking pin at the top of the first chamber. Lower the chamber to the ground to connect chambers.

**NOTE:** When the chamber end is placed between the connector hook and locking pin at a 45-degree angle, the pin will be visible from the back side of the chamber.

**NOTE:** The connector hook serves as a guide to ensure proper connection and does not add structural integrity to the chamber joint. Broken hooks will not affect the structure or void the warranty.

7. Swivel the chamber on the pin to achieve the proper direction for the trench layout.



Place endcap inlet end.

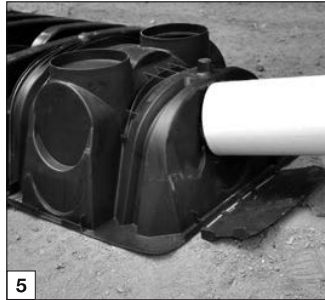

Insert inlet pipe.



Connect chambers.

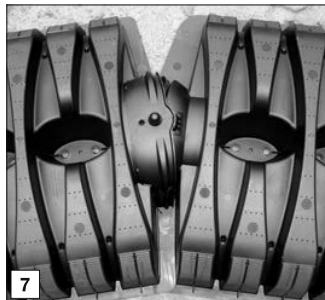

Swivel chambers.

**NOTE:** The chamber allows up to 10-degree swivel in either direction at each joint.

8. Continue connecting chambers until the trench is completed.

Note: As chambers are installed, verify they are level or have the prescribed slope.

9. The last chamber in the trench requires an endcap. Lift the endcap at a 45-degree angle and align the connector hook on the top of the chamber with the raised slot on the top of the endcap. Lower the endcap to the ground and into place.

**NOTE:** Place a few shovels of soil around the endcap to secure it during backfill.

10. To ensure structural stability, fill the sidewall area by pulling soil from the sides of the trench with a shovel. Start at the joints where the chambers connect. Continue backfilling the entire sidewall area, making sure the fill covers the louvers.

11. Pack down fill by walking along the edges of trench and chambers.

Note: In wet or clay soils, do not walk in the sidewalls.

12. Proceed to the next trench and begin with Step 1.



Place endcap outlet end.

# INSTALLATION INSTRUCTIONS

## Trench Systems

### Installing Optional Quick4 Inspection Ports

1. With a hole saw drill the pre-marked area in the top of the chamber to create a 4-inch opening.
2. Set a cut piece of pipe of the appropriate length into the corresponding chamber's inspection port sleeve.

Note: The sleeve will accommodate a 4-inch SCH40 pipe.

3. Use two screws to fasten the pipe to the sleeve around the inspection port.
4. Attach a threaded cap or cleanout assembly onto the protruding pipe at the appropriate height.
5. A small valve cover box may be used if inspection port is below the desired grade.

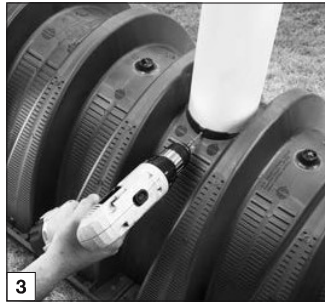

Fasten the pipe.

### Installing Optional Quick4 Plus Inspection Ports

Inspection ports may be installed on the chamber or the Quick4 Plus All-in-One 8 Endcap. The Quick4 Plus Endcap does not allow inspection port construction.

#### Quick4 Plus All-in-One 8 Inspection Port

1. With a hole saw drill the pre-marked area in the top of the Quick4 Plus All-in-One 8 Endcap to create a 4-inch opening.
2. Set a cut piece of pipe of the appropriate length into the corresponding endcap's inspection port sleeve.

**NOTE:** Sleeve will accommodate up to a 4-inch Schedule 40 pipe.

3. Use two screws to fasten pipe to the sleeve around the inspection port.
4. Attach a threaded cap or cleanout assembly onto the protruding pipe at appropriate height.
5. A small valve cover box may be used if inspection port is below desired grade.



All-in-One 8 inspection port.

### Chamber Inspection Port

1. With a hole saw drill the pre-marked area in the top of the chamber to create a 2.5-inch opening.
2. Set a cut piece of pipe of appropriate length into the corresponding chamber's inspection port sleeve.

Note: The sleeve will accommodate up to a 2.5-inch Schedule 40 pipe.



Chamber inspection port.

### Covering the System

**Before backfilling, the system must be inspected by a health officer or other official as required by State and local codes. Create an as-built drawing at this time for future records.**

1. Backfill the trench by pushing fill material over the chambers with a backhoe. Keep a minimum of 12 inches of compacted cover over the chambers before driving over the system.

Note: Do not drive over system while backfilling in sand.

**NOTE:** For shallow cover applications, you must mound 12 inches of soil over the system before driving over it, and then grade it back to 6 inches upon completion.

2. It is best to mound several inches of soil over the finish grade to allow for settling. This also ensures runoff water is diverted away from the system.

3. After the system is covered, site should be seeded or sodded (per state and local requirements) to prevent erosion.

**NOTE:** If the system is for new home construction it is important to leave marking stakes along the boundary of the system. This will notify contractors of the site location so they will not cross it with equipment or vehicles.

# SPECIAL PROCEDURES

## Installing Filter Fabric\*

**Infiltrator Systems, Inc. suggests (non-mandatory) the installation of filter fabric over chambers when installed in uncompacted, fine/very-fine sands, and when the following conditions exist:**

- Installations left uncovered for extended periods of time.
- Drainfield area not sodded immediately after final cover-up.
- Drainfield located in area where infiltrative surface is less than 24" above seasonal high water table.

### Filter Fabric Specifications:

- Fabric shall be non-woven
- Weight: 0.35 oz./s.y. to 1 oz./s.y.
- Apparent Opening Size (AOS): 20-30 U.S. Sieve (ASTM D 4571)

Note: Filter fabric on an Infiltrator chamber does not affect the warranty.

Place fabric lengthwise over chamber so sidewall is completely covered. See below.



## 90-Degree Bend Application

**BED DETAIL PLAN VIEW**  
(not to scale)

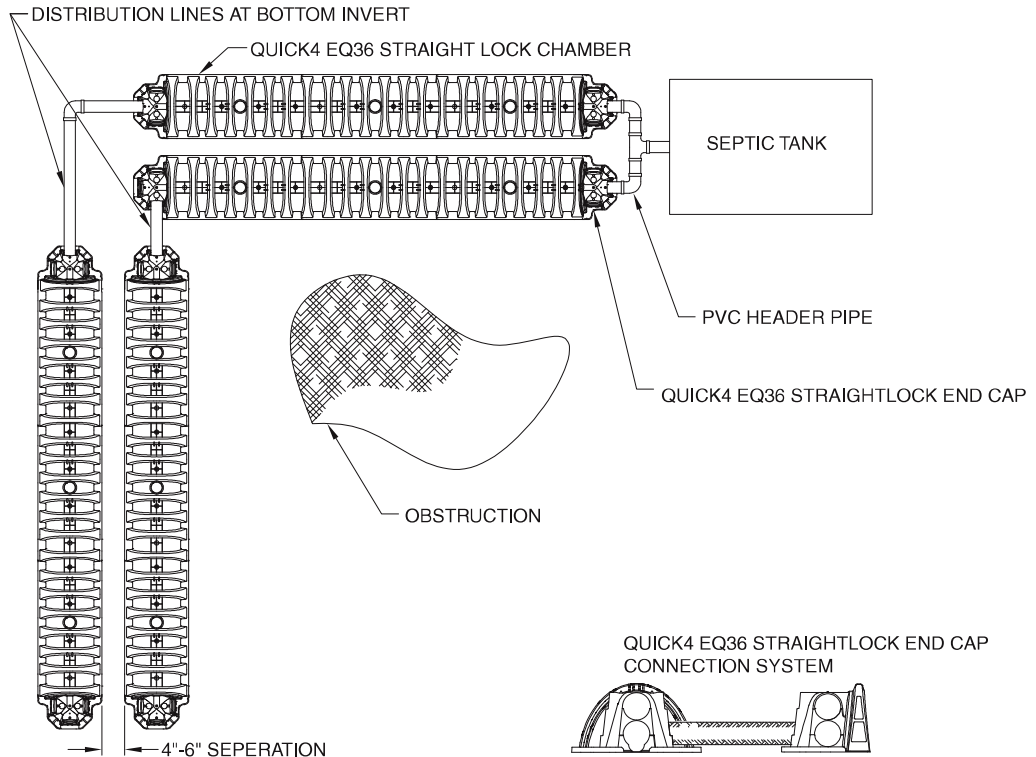

## SPECIAL PROCEDURES

### Low Pressure Distribution Systems

Note: Where the total required area of drainfield is greater than 1000 square feet, an automatic dosing device shall be used. The device discharges into a low-pressure distribution network designed by a registered engineer (Chapter 64E-6 State of Florida DOH Administrative Code).

#### Method A

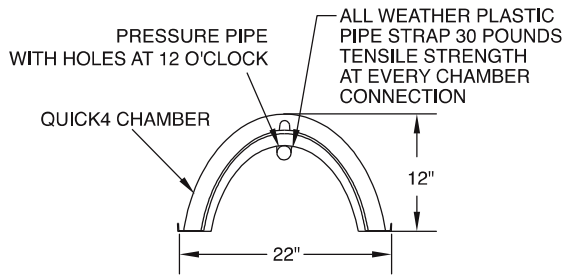

1. Use Schedule 40 PVC pipe and fittings ranging from 1.25"- 2" (1.25" Typ.) as the discharge pipe to be suspended inside the chambers.
2. Connect piping to be used in the length of the field line by aligning the lettering on the pipe.
3. Drill specified holes at specified spacing along lettering to ensure a straight line. Mark the inlet end of the discharge pipe along lettering.
4. Connect all chambers at interlocking joints in a field line and secure each joint with a drywall screw on each side of the chamber.
5. Roll an entire row of chambers over so that the top of the chambers are lying on the soil and the feet of the chambers are facing upward.
6. Lay the discharge pipe inside the entire chamber field line and secure pipe with all-weather plastic tie straps spaced approximately every 4 feet. Be sure to leave about 1 foot of pipe stemming from the inlet end of the chamber for header connection. The distal end of the field line may be capped off inside the endcap of the last chamber or extended to the surface as a cleanout, per design.
7. Once the discharge pipe is secured, roll the row of chambers to an upright position.
8. With a hole saw, drill out the appropriate diameter hole in each endcap to accommodate pipe.
9. Insert the pipe through the hole in the endcap and slide the endcap to attach to the chamber field line.
10. Repeat these steps for each field line.
11. Connect the pipes stemming from the inlet end as the header assembly. Be sure that the mark on the pipe is facing the 12 o'clock position when connecting header. This is to ensure that the discharge holes are facing upward.

12. Backfill according to instructions.

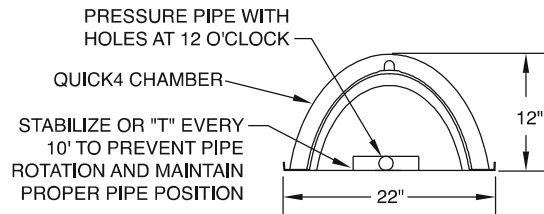

#### Method B

1. Use Schedule 40 PVC pipe and fittings ranging from 1.25"- 2" (1.25" Typ.) in diameter to be laid on the infiltrative surface underneath the chambers.
2. Connect piping to be used in the length of the field line by aligning the lettering on the pipe. The lettering should be facing upward. At every 10' section connect the pipe using a 4-way cross fitting. These fittings will stabilize the discharge pipe when the pump is switched on. Be sure to cap off the sides of the fittings not being used and the end of the field line.
3. Drill specified holes at specified spacing along lettering to ensure a straight line. Again, the holes must be facing upward.
4. Lay the pipe in the trench/bed and begin connecting the chambers over the discharge pipe. The pipe should be centered under the chambers. Leave about 1 foot of pipe stemming from the inlet-end of the chamber for header connection.
5. With a hole saw, drill out the appropriate diameter hole in each endcap to accommodate pipe.
6. Insert the pipe through the hole in the endcap and slide the endcap to attach to the chamber field line.
7. Repeat steps 1-4 for each field line.
8. Connect header assembly.
9. Backfill according to instructions.

# SPECIAL PROCEDURES

## Low Pressure Distribution Systems

### Low Pressure Distribution with Quick4 Plus EQ36 LP Chambers

#### Installing the Chambers and Endcaps

1. To allow pressure laterals to drain after each dose, drill a hole in the bottom of pipe at end of pressure line. Place the snap-off splash plate or a paving block of equal or larger length and width as splash plate (not to exceed area of endcap) at the bottom of trench to protect the infiltrative surface from erosion.

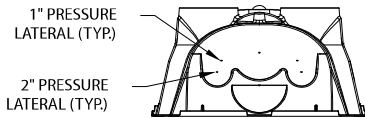

2. With a hole saw, drill out the appropriate diameter hole to accommodate the pressure lateral pipe.



2 Drill pressure pipe hole.

3. Insert pressure lateral pipe into the endcap's drilled opening and slide it into the manifold pipe. Glue pressure lateral pipe to manifold pipe.

4. With pressure lateral pipe through endcap, place back edge of endcap over the inlet end of first chamber. Be sure to line up locking pins on top both chamber and endcap.



4 Place endcap over inlet end.

**NOTE:** Health departments may require a wet-run pressure check to be done prior to chamber installation when the pipe is laying on the ground. Check with your local health department for the proper procedure.

5. (Method A) With the holes pointing up, secure pressure lateral pipe to top of first chamber with a plastic pipe strap at outlet end of the unit. Slide strap up through slot in chamber top, down through other slot, and cinch the two ends around the pipe.



5 Secure pressure pipe.

6. (Method B) With holes pointing up, stabilize pressure lateral pipe on ground to prevent from moving.

7. Lift and place next chamber onto previous one at a 45-degree angle. Line up the chamber end between connector hook and locking pin at top of the first chamber. Lower it to ground to engage the interlocks.

8. (Method A) Secure lateral pipe to top of the next chamber once in place. Follow the same method in Step 5.

9. Continue interlocking chambers and securing the pipe until the trench is completed.

10. Before attaching the final endcap, it may be necessary to remove the tongue of the connector hook on the last chamber with a pair of pliers depending on your pipe diameter.

11. Insert the pressure lateral pipe through the hole in the final endcap and slide the endcap toward the last chamber. Lift the endcap over the modified connector hook and push straight down to secure it to the chamber.



11 Lateral pipe through endcap.

**NOTE:** If cleanout extensions are required, use a hole saw to cut a hole in the top of Q4 Plus All-in-One 8 Endcap so the pressure lateral pipe with an elbow can extend to the ground surface. For cleanout access, use the "Installing Optional Inspection Ports" section in the general installation instructions.

12. If installing multiple rows of chambers, follow Steps 1-9 to lay next row of chambers parallel to the first. Keep a minimum separation distance between each row of chambers as required by local code.

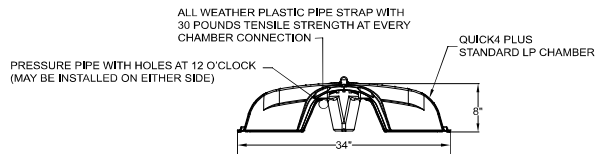

#### Advantages of Method A

- Pipe and orifice placed closer to the chamber dome offer improved distribution.
- Pipe positioned at the top of the chamber places it well above effluent.
- Plastic pipe hanger easily secures pipe in place.

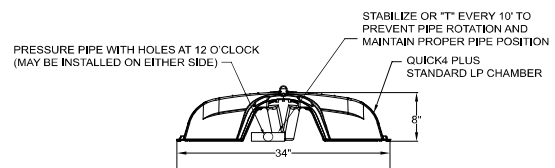

#### Advantages of Method B

- Pipe resting on trench bottom allows easy installation and maintenance.
- Stabilizing "T"s keep pipe level.
- System promotes efficient pressure checks.
- Pipe resting on trench bottom allows easier inspections if monitor ports are installed.

# WARRANTIES

---

## Florida Warranties

### Limited Septic Warranty for Infiltrator Chambers

(a) The structural integrity of each Infiltrator chamber and endcap, when installed in accordance with manufacturer's instructions, is warranted to the original purchaser against defective materials and workmanship for two years from the date of purchase. Should a defect appear within the warranty period, purchaser must inform Infiltrator Systems Inc. of the defect within fifteen (15) days. Infiltrator Systems will supply a replacement chamber and/or endcap. Infiltrator Systems' liability specifically excludes the cost of removal and/or installation of units.

(b) THE WARRANTY IN SUBPARAGRAPH (a) IS EXCLUSIVE. THERE ARE NO OTHER WARRANTIES WITH RESPECT TO THE CHAMBERS AND Endcaps, INCLUDING NO WARRANTIES OF MERCHANTABILITY OR OF FITNESS FOR A PARTICULAR PURPOSE. THE WARRANTY DOES NOT EXTEND TO INCIDENTAL, CONSEQUENTIAL, SPECIAL, OR INDIRECT DAMAGES. THE COMPANY SHALL NOT BE LIABLE FOR PENALTIES OR LIQUIDATED DAMAGES, INCLUDING LOSS OF PRODUCTION AND PROFITS, LABOR AND MATERIALS, OVERHEAD COSTS, OR OTHER LOSS OR EXPENSE INCURRED BY PURCHASER. SPECIFICALLY EXCLUDED FROM WARRANTY COVERAGE ARE DAMAGE TO THE UNITS DUE TO ORDINARY WEAR AND TEAR, ALTERATION, ACCIDENT, MISUSE, ABUSE, OR NEGLIGENCE OF THE UNITS; THE UNITS BEING SUBJECTED TO STRESSES GREATER THAN THOSE PRESCRIBED IN THE INSTALLATION INSTRUCTIONS; THE PLACEMENT BY PURCHASER OF IMPROPER MATERIALS INTO THE PURCHASER'S SYSTEM; OR ANY OTHER EVENT NOT CAUSED BY THE COMPANY. FURTHERMORE, IN NO EVENT SHALL THE COMPANY BE RESPONSIBLE FOR ANY LOSS OR DAMAGE TO THE PURCHASER, THE UNITS, OR ANY THIRD PARTY RESULTING FROM ITS INSTALLATION OR SHIPMENT. PURCHASER SHALL BE SOLELY RESPONSIBLE FOR ENSURING THAT THE INSTALLATION OF THE SYSTEM IS COMPLETED IN ACCORDANCE WITH ALL APPLICABLE LAWS, CODES, RULES, AND REGULATIONS.

(c) NO REPRESENTATIVE OF THE COMPANY HAS THE AUTHORITY TO CHANGE THIS WARRANTY IN ANY MANNER WHATSOEVER, OR TO EXTEND THIS WARRANTY. NO WARRANTY APPLIES TO ANY PARTY OTHER THAN TO THE ORIGINAL PURCHASER.

(d) All types of chamber systems must be installed in full compliance with the latest version of the product installation requirements. The system must be in full compliance with all aspects of the state regulations and codes.

### Performance Warranty for Quick4 Chambers

(a) Infiltrator warrants that each Quick4 chamber and MultiPort endcap manufactured by Infiltrator (collectively, the "Units"), when installed and operated in a leachfield of an onsite septic system of a single family residence in accordance with Infiltrator's instructions, for a period of two (2) years from the date of installation (i) shall be free from defective materials and workmanship; and (ii) shall perform in such a manner to absorb effluent within the design flow rate for the septic system containing the Units, so that there will be no sewage backup into the dwelling or structure which uses the septic system, or visible pooling of effluent around the system. The presence of such sewage backup or such visible pooling shall constitute a "failure" of the system. This Limited Warranty covers new permitted leachfield installations only, and does not cover repairs, extensions or additions to existing leachfields. This Limited Warranty extends only to the original purchasing contractor. For this Limited Warranty to apply, the Units must be installed in accordance with all necessary permits and in accordance with all site conditions required by state and local codes for the installation of gravel and pipe systems, and must be sized according to Infiltrator specifications and state, county and local requirements.

In order to exercise these Limited Warranty rights, the warranty holder must notify Infiltrator in writing at its corporate headquarters in Old Saybrook, Connecticut (address below) within fifteen (15) days of any alleged defect or failure. The notice shall be accompanied by (i) a letter from a state licensed septic tank contractor or Professional engineer detailing cause of failure (ii) a copy of the appropriate permit and design for the septic system; and (iii) proof to Infiltrator's satisfaction that the septic tank has been pumped at least once every three (3) years since installation. Upon notification of a possible breach of warranty, Infiltrator may undertake an investigation of the circumstances of the possible breach. At its discretion, Infiltrator may perform tests to determine the cause of any breach and may hire a soil scientist or professional engineer or use Infiltrator personnel to evaluate soil conditions and otherwise assist in the investigation.

In the event that Infiltrator determines that there has been a breach of this Limited Warranty due to a failure, Infiltrator will, at its option, either: provide Units as it deems necessary to extend the size of the leachfield and a fee of \$12.50 per Unit toward the cost of installation; or provide an equivalent, state-approved solution to cure the breach. Infiltrator will not be responsible for pumps or any other necessary mechanical devices needed to extend or repair the leachfield following a failure, nor shall Infiltrator be liable for the addition of pump systems or underground water diversion systems, or repair or replacement of any landscape or irrigation systems, following a Failure.

In the event of any other breach of this Limited Warranty, Infiltrator will, at its option, either: provide replacement Units for Units determined by Infiltrator to be defective and a fee of \$12.50 per Unit toward the cost of installation; or provide an equivalent state-approved solution to cure the breach. Infiltrator's liability under this Standard Limited Warranty specifically excludes any other cost of removal and/or installation of the Units.

(continued)

## WARRANTIES

(b) THIS LIMITED WARRANTY AND THE REMEDIES IN SUBPARAGRAPH (a) ARE EXCLUSIVE. THERE ARE NO OTHER WARRANTIES TO THE ORIGINAL PURCHASING CONTRACTOR WITH RESPECT TO THE UNITS, INCLUDING NO IMPLIED WARRANTIES OF MERCHANTABILITY OR FITNESS FOR A PARTICULAR PURPOSE.

(c) This Limited Warranty shall be void if any part of the chamber system (chamber or endcap) is manufactured by anyone other than Infiltrator. The Limited Warranty does not extend to incidental, consequential, special or indirect damages. Infiltrator shall not be liable for penalties or liquidated damages, including loss of production and profits, labor and materials, overhead costs, or other losses or expenses incurred by the warranty holder or any third party. Specifically excluded from Limited Warranty coverage are damage to the Units due to Acts of God or natural disasters; ordinary wear and tear, alteration, accident, misuse, abuse or neglect of the Units; the Units being subjected to vehicle traffic or other conditions which are not permitted by the installation instructions; failure to maintain the minimum ground cover set forth in the installation instructions; the placement of improper materials into the system containing the Units; failure of the Units or the septic system due to improper siting or improper sizing, improper specified backfill, excessive water usage, improper grease disposal, or improper operation; or any other event not caused by Infiltrator. This Limited Warranty shall be void if the warranty holder fails to comply with all of the terms set forth in this Limited Warranty, including the information required by subparagraph (a).

Furthermore, in no event shall Infiltrator be responsible for any loss or damage to the warranty holder, the Units, or any third party resulting from installation (except as expressly set forth in subparagraph (a) or shipment, or from product liability claims of the warranty holder or any third party. For this Limited Warranty to apply, the Units must be installed in accordance with all site conditions required by state and local codes, all other applicable laws, and Infiltrator's written instructions.

(d) No representative of Infiltrator has the authority to change this Limited Warranty in any manner whatsoever, or to extend this Limited Warranty. No warranty applies to any party other than the original purchasing contractor.

NOTE: Any chamber systems constructed with less than our minimum sizing requirements will not be covered by any product warranties.

NOTE: In fine and very fine sands, loamy sand and sandy loam soils with low moisture content, it is at the contractor's discretion to cover the chambers with very fine filter cloth or paper prior to backfilling the system. Standard installation instructions apply.

Version March 16, 2015 rev  
Approved Florida Department of Health, Onsite Sewage Programs  
April 6, 2015



4 Business Park Road  
P.O. Box 768  
Old Saybrook, CT 06475  
860-577-7000 • Fax 860-577-7001  
**1-800-221-4436**  
[www.infiltratorsystems.com](http://www.infiltratorsystems.com)

U.S. Patents: 4,759,661; 5,017,041; 5,156,488; 5,336,017; 5,401,116; 5,401,459; 5,511,903; 5,716,163; 5,588,778; 5,839,844 Canadian Patents: 1,329,959; 2,004,564 Other patents pending. Infiltrator, Equalizer, Quick4, and SideWinder are registered trademarks of Infiltrator Systems, Inc. Infiltrator is a registered trademark in France. Infiltrator Systems, Inc. is a registered trademark in Mexico. Contour, MicroLeaching, PolyTuff, ChamberSpacer, MultiPort, PosiLock, QuickCut, QuickPlay, SnapLock and StraightLock are trademarks of Infiltrator Systems, Inc. PolyLok is a trademark of PolyLok, Inc. TUF-TITE is a registered trademark of TUF-TITE, INC. Ultra-Rib is a trademark of IPEX Inc.

© 2015 Infiltrator Systems, Inc. All rights reserved. Printed in U.S.A.

C33 03151SI

Contact Infiltrator Systems' Technical Services Department for assistance at 1-800-221-4436